



ideal-tek

manufacturer & supplier of precision instruments 



implantologia dental
implantologie dentaire

Dental Implantology Zahnärztliche Implantologie

Zahnärztliche Chirurgie
Dental surgery
Chirurgia dentale
Cirugia dental
Chirurgie dentaire



Implantologia dental
Implantologie dentaire

Dental Implantology

Zahnärztliche Implantologie

Zahnärztliche Chirurgie
Dental surgery
Chirurgia dentale
Cirugia dental
Chirurgie dentaire

Feine Scheren

Delicate Scissors

Forbici delicate

Tijeras finas

Ciseaux délicate

Stumpf - Blunt
Smussa - Romas
Mousse

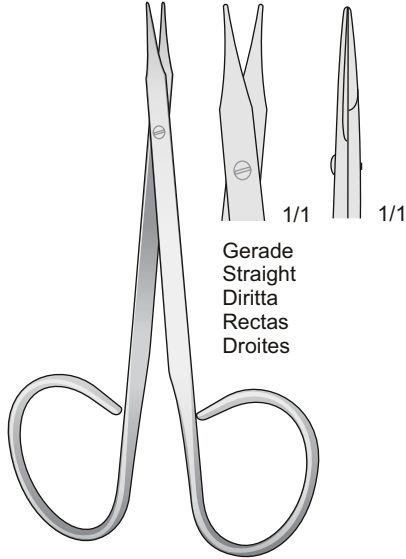

STEVENS
0607-CAL
100 mm

Stumpf - Blunt
Smussa - Romas
Mousse

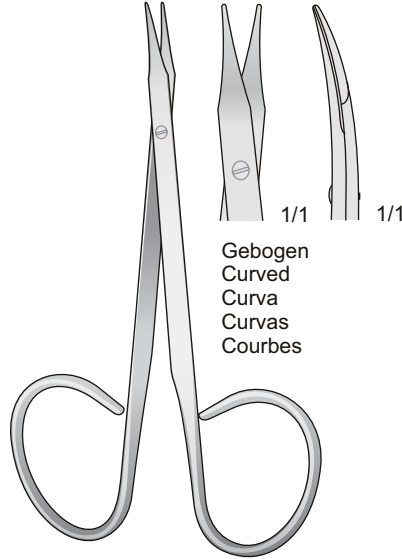

STEVENS
0607-CBA
100 mm

Gezahnt - Serrated
Dentellate - Dentelés
Dentadas

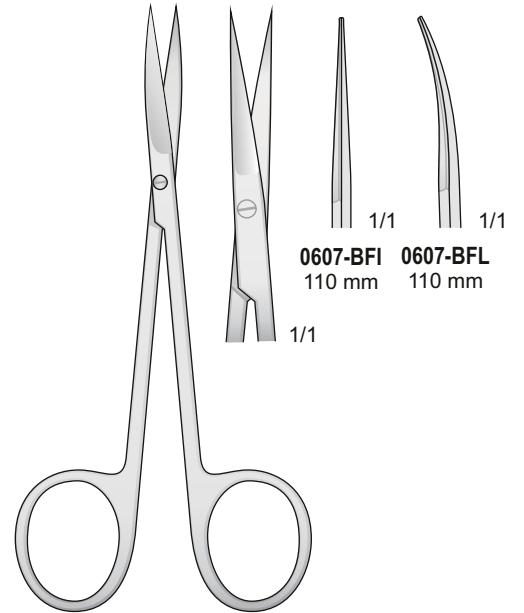

0607-BFI/0607-BFL
110 mm

Spitz - Sharp
Acuta - Aguda
Pointu

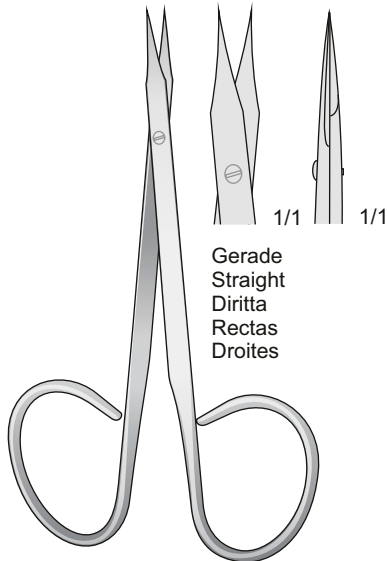

WALTON
0607-CBB
100 mm

Spitz - Sharp
Acuta - Aguda
Pointu

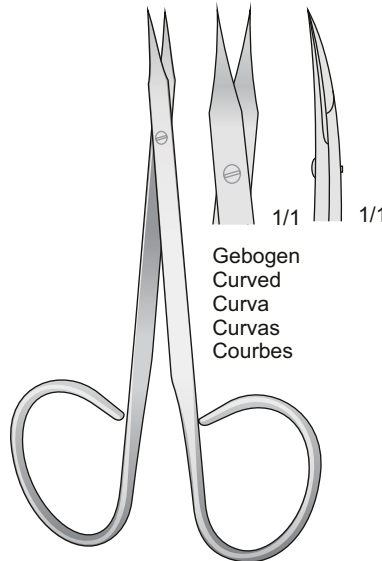

WALTON
0607-CBC
100 mm

Spitz - Sharp
Acuta - Aguda
Pointu

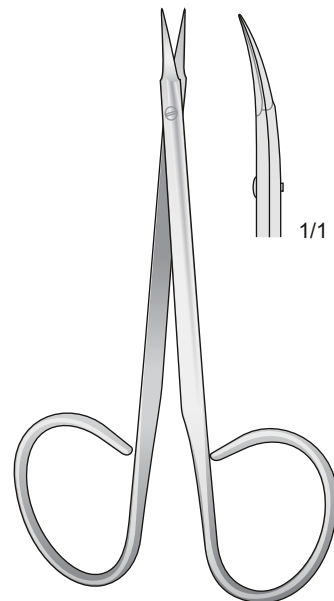

STITCH
0607-CBG
115 mm

Chirurgische Scheren

Surgical scissors

Forbici chirurgiche

Tijeras quirúrgicas

Ciseaux chirurgicaux

Spitz - Sharp - Acuta - Agudo - Aigu

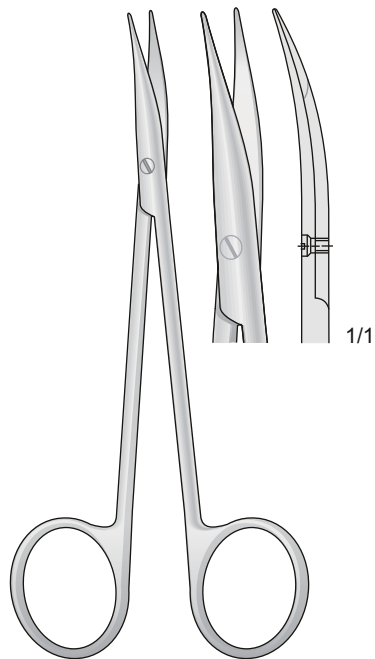

JAMESON-WERBER
0607-BCD
130 mm

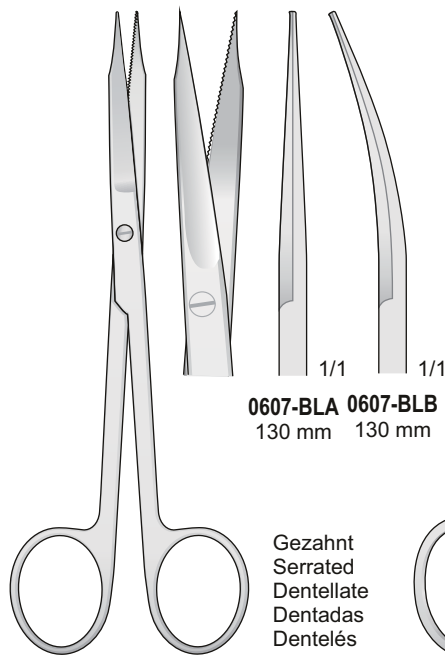

GOLDMAN-FOX
0607-BLA/0607-BLB
130 mm

0607-BLA 0607-BLB
130 mm 130 mm

Gezahnt
Serrated
Dentellate
Dentadas
Dentelés

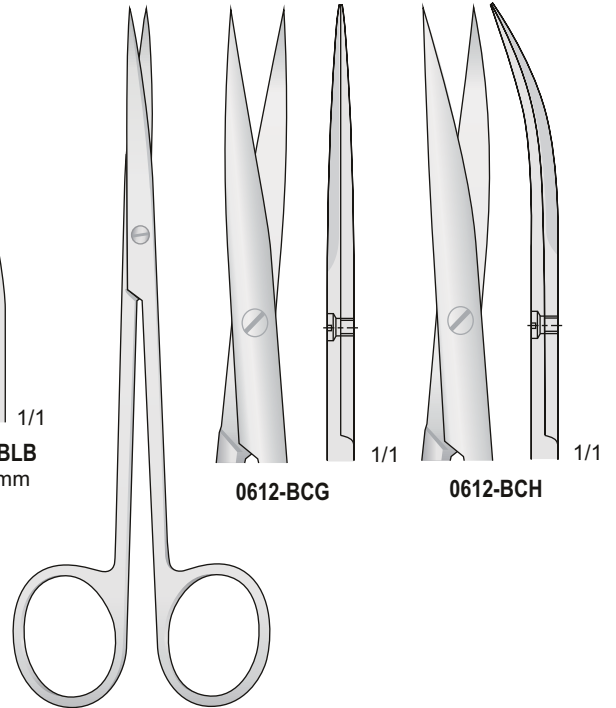

METZENBAUM
0612-BCG/0612-BCH
145 mm

0612-BCG

0612-BCH

Mit Hartmetalleinsätzen - Tungsten-carbide scissors
Con punta al carburo di tungsteno - Tijeras de tungsteno
Avec plaquettes en carbure de tungstène

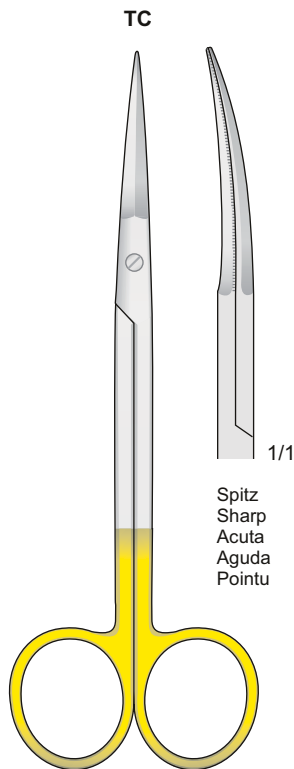

PECK-JOSEPH
0607-LC
140 mm

TC

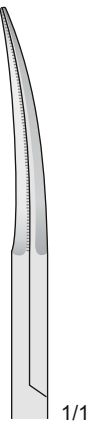

Spitz
Sharp
Acuta
Aguda
Pointu

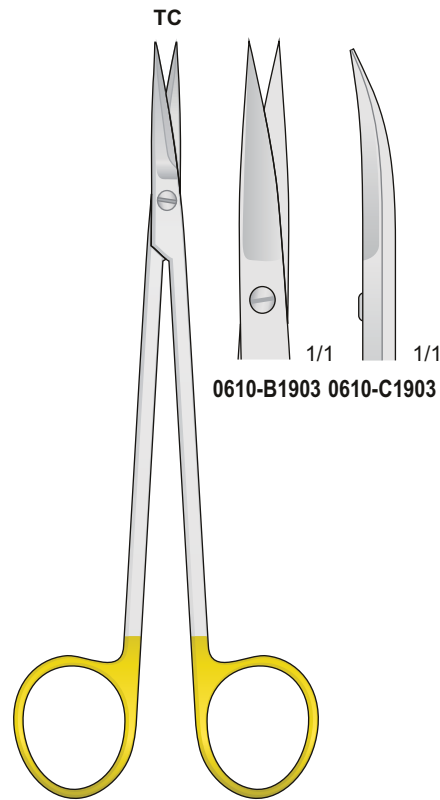

KELLY
0610-B1903/0610-C1903
160 mm

TC

0610-B1903 0610-C1903

“Super-cut” Scheren micro-schliff für tissue atrauma
 “Super-cut” scissors for gripping tissue and cutting interproximally
 Forbici “Super-cut” estremamente taglienti per tessuti con riduzione del trauma
 Tijeras “super cortes” para cortar tissute-atrauma
 Ciseaux “super cut” coupe les tissus en reduisant les risques de traumatisme

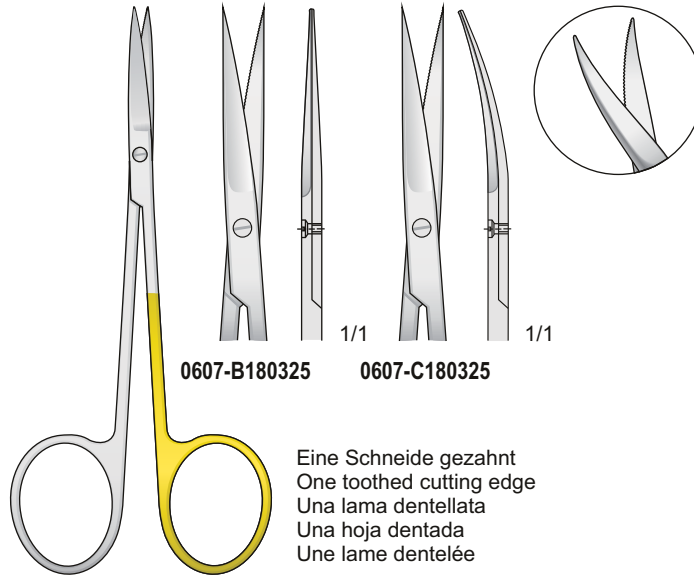

0607-B180325/0607-C180325
110 mm

Scheren mit Wellenschliff auf einer Schnittfläche
 Scissors cut one serrated cutting edge
 Forbici con taglio ondulato su una lama - Tijeras con onda afilados
 Ciseaux avec affutage spécial ont une lame dentée

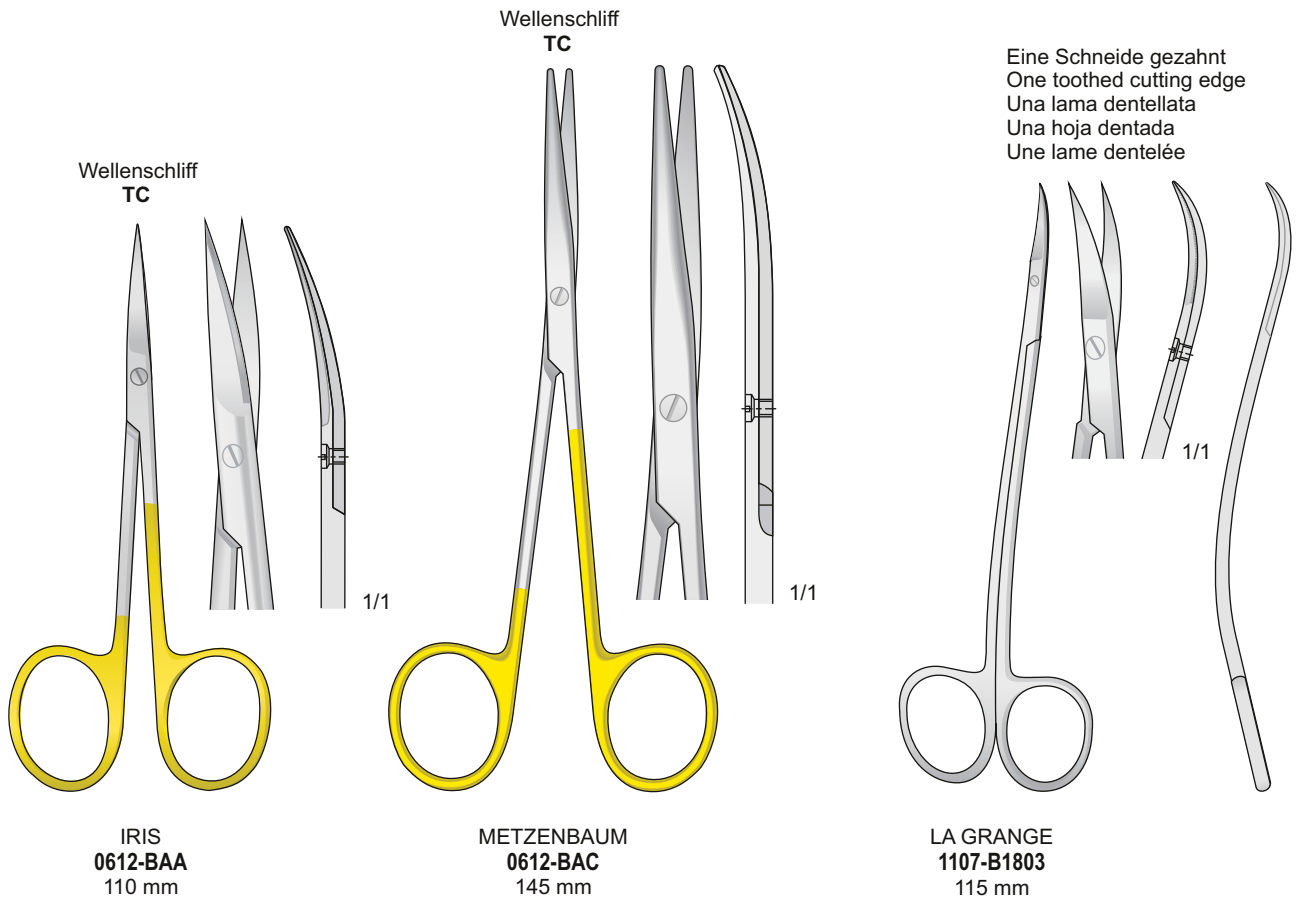

Chirurgische Scheren

Surgical scissors

Forbici chirurgiche

Tijeras quirúrgicas

Ciseaux chirurgicaux

Eine Schneide gezahnt - One toothed cutting edge
Una lama dentellata - Una hoja dentada - Une lame dentelée

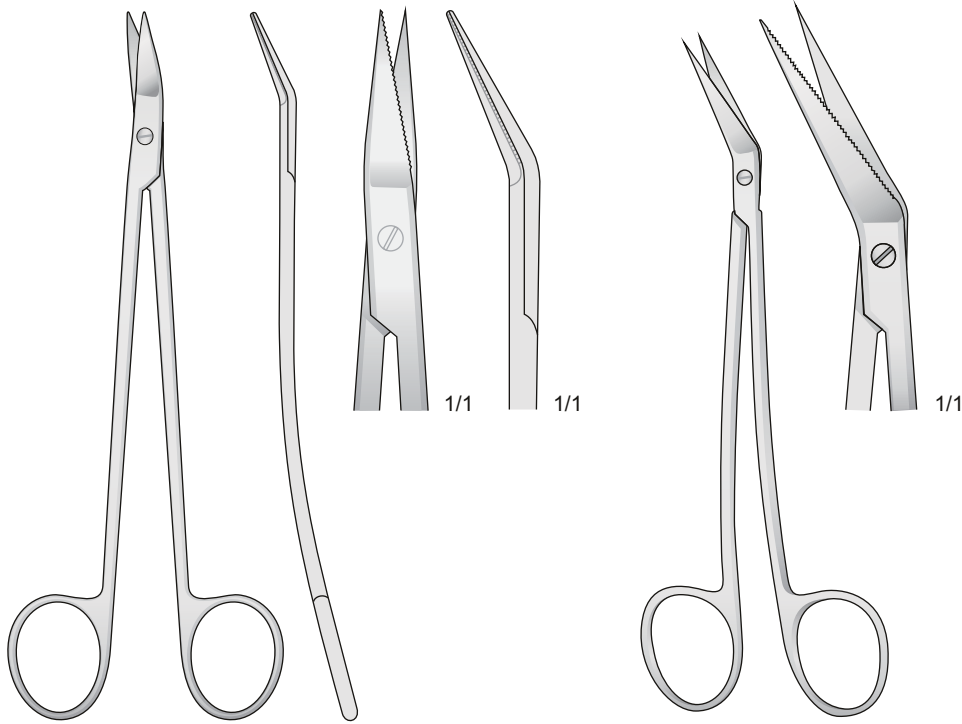

DEAN
04050113
180 mm

LOCKLIN
1110-C
160 mm

Drahtschere
Wire Cutting Scissors
Forbici per fili
Tijeras para Alambre
Ciseaux à fils

Ligaturscheren - Suture Scissors
Forbici per suture - Tijeras pad 1fura ligaduras
Ciseaux pour sutures

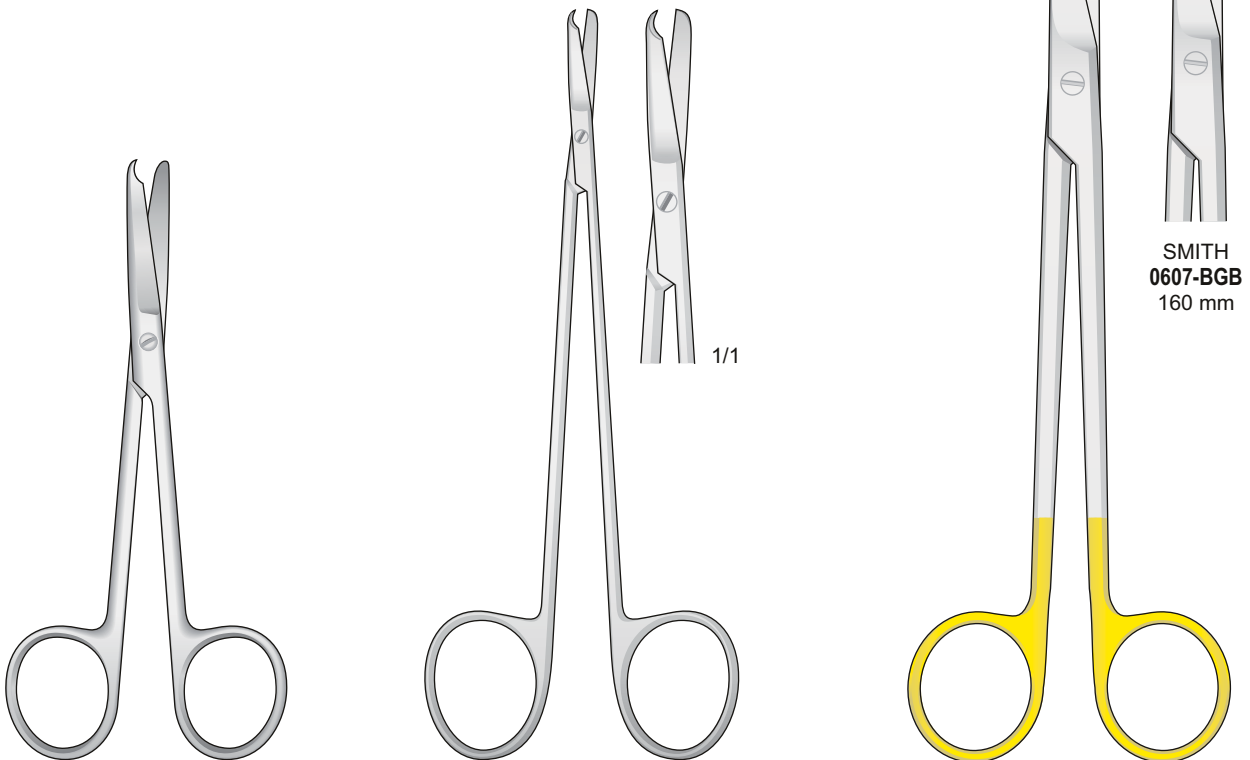

SPENCER
1803-BE
120 mm

KELLY
1803-BG
150 mm

SMITH
0607-BGA
160 mm

SMITH
0607-BGB
160 mm

Chirurgische und Anatomische Pinzetten

Tissue Pliers and Dressing forceps

Pinzette chirurgiche e anatomiche

Pinzas quirúrgicas y anatómicas

Pinces chirurgicales et Anatomiques

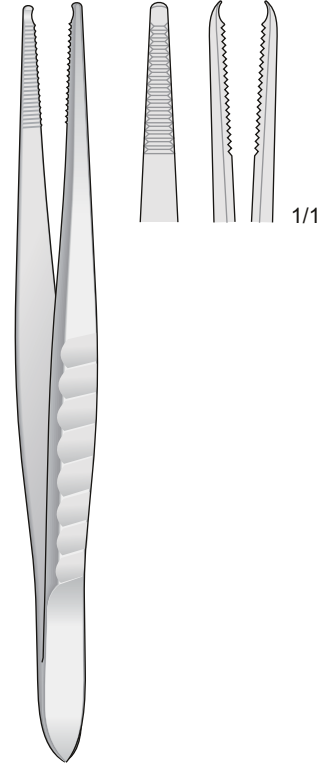

0204-CHA
130 mm

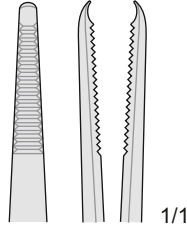

1/1



0204-DFB/0204-DFG

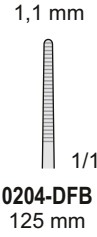

0204-DFB
125 mm

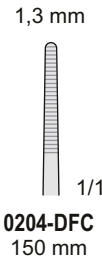

0204-DFC
150 mm

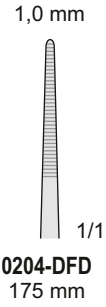

0204-DFD
175 mm

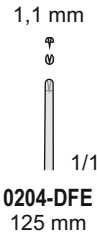

0204-DFE
125 mm

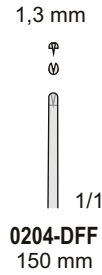

0204-DFF
150 mm



0204-DFG
175 mm

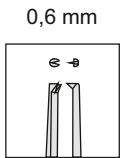

0,6 mm

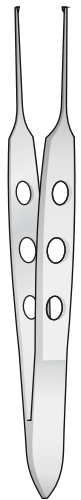

BISHOP-HARMON
1206-BHH
85 mm



CORN
0401-AH
150 mm

Nahtpinzetten zum Halten von Gewebe und Membranen
Suture Pliers for holding Tissue and Membranes
Pinzette per sutura per tenere fermi tessuti e membrane
Pinzas de sutura para sostener tejidos y membranas
Pince de suture pour le maintien de tissus et de membranes

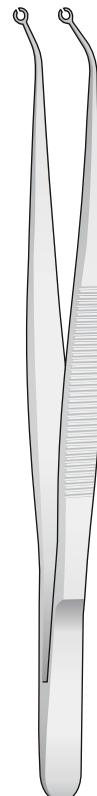

Ø Int 1.6 mm
1/1
0204-BFI

Ø Int 2.2 mm
1/1
0204-BFL

0204-BFI/0204-BFL
160 mm

Nahtpinzetten
Suture Pliers
Pinzette per sutura
Pinzas de sutura
Pince à suture

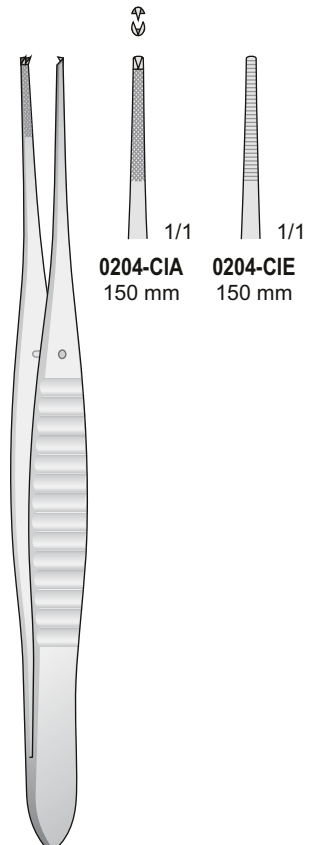

1/1
0204-CIA
150 mm

1/1
0204-CIE
150 mm

GILLIES
0204-CIA/0204-CIE
150 mm

Chirurgische Pinzetten
Atraumatische Pinzetten

Tissue Forceps
Non-traumatic forceps

Pinzette chirurgiche
Pinzette atraumatiche

Pinzas quirùrgicas
Pinzas Atraumáticas

Pincas quirurgicales
Pincas Atraumaticas

Mit Hartmetalleinlage
With Tungsten-carbide inserts
Con inserti al carburo di tungsteno
Pinzas con plaquitas de carburo de tungsteno
Avec plaquettes en carbure de tungstène

Mikro diamantiertes Maul
Micro punta diamantata
Micro boca diamantata
Micro mors diamanté

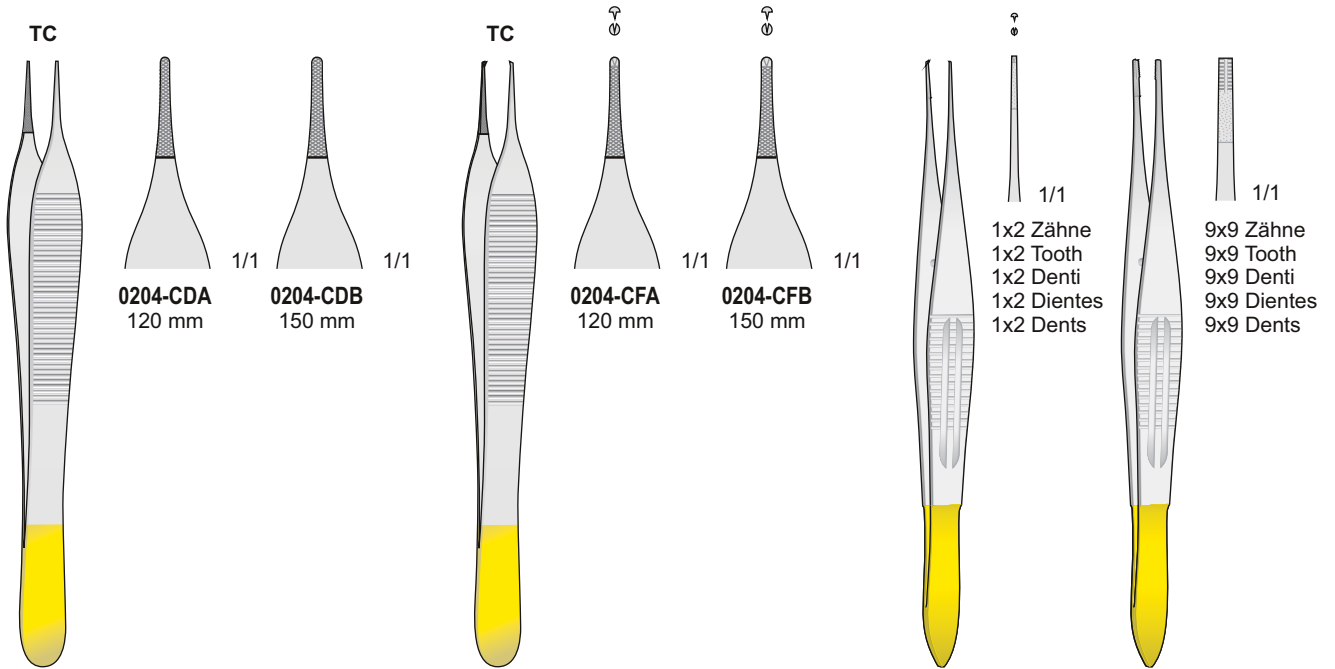

ADSON
0204-CDA/0204-CDB

ADSON
0204-CFA/0204-CFB

CASTROVIEJO
0204-DEI 0.9 mm
120 mm

BROWN
0204-DEL
120 mm

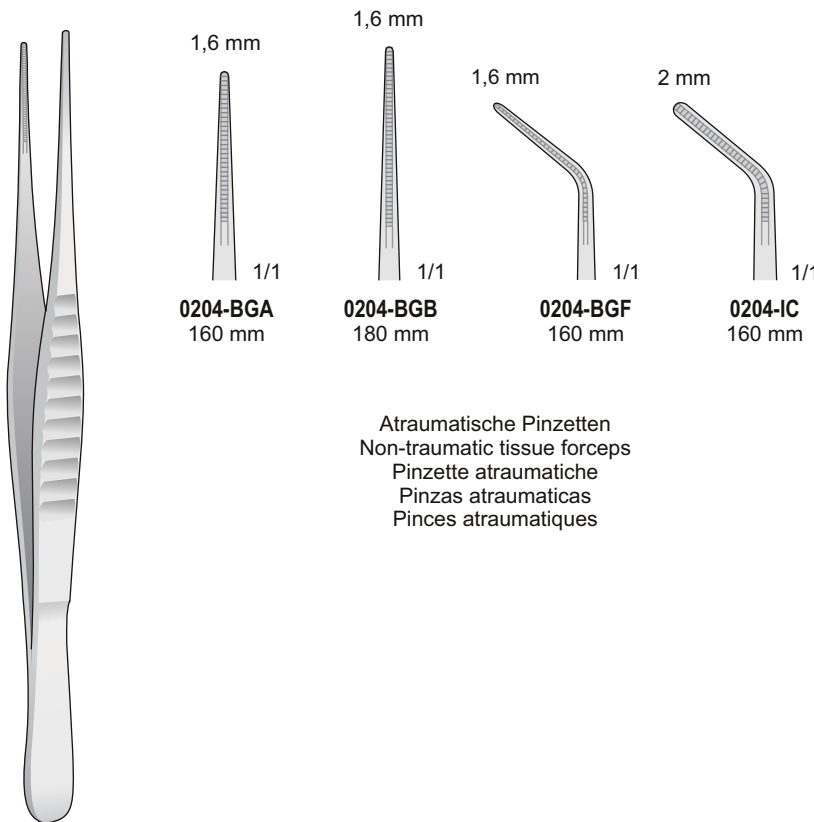

DE BAKEY
0204-IC/0204-BGF

Atraumatische Pinzetten
Non-traumatic tissue forceps
Pinzette atraumatiche
Pinzas atraumaticas
Pincas atraumaticas

ADSON-BROWN
0204-CFD
120 mm

Chirurgische und Anatomische Pinzetten

Tissue Pliers and Dressing forceps

Pinzette chirurgiche e anatomiche

Pinzas quirúrgicas y anatómicas

Pincas quirúrgicas et Anatomiques

Pinzette zum Halten Membranen
 Membrane Holding forceps
 Pinza per fissaggio membrane
 Pinza para sostener membranas
 Pince pour le maintien membranes

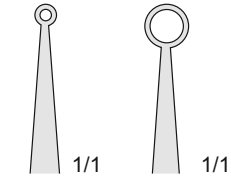

0204-FG

0204-FH

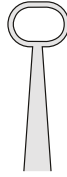

0204-FI



0204-FL

0204-FG/0204-FL
100 mm

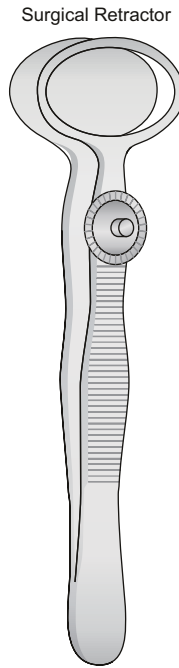

Surgical Retractor

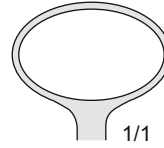

0204-BDA
20 mm

DESMARRES
0204-BDA
90 mm

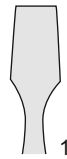

KÜHNE
0518-EE
105 mm

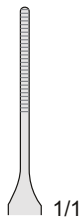

GERALD
1206-BAB
180 mm

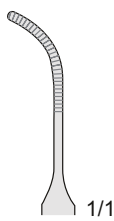

GERALD
1206-BAC
180 mm

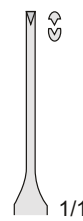

GERALD
1206-BAD
180 mm

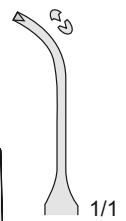

GERALD
1206-BAE
180 mm

Titan-Pinzetten

Titanium Tissue forceps

Pinzette in titanio

Pinzas de titanio

Pinces en titane

Titan - Titanium - Titanio - Titane

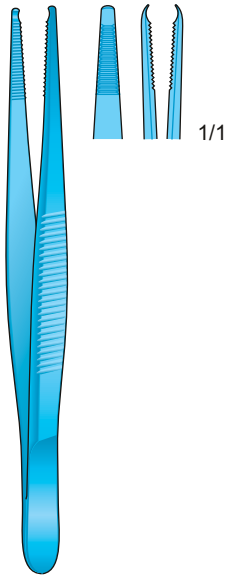

0204-CIF19
90 mm

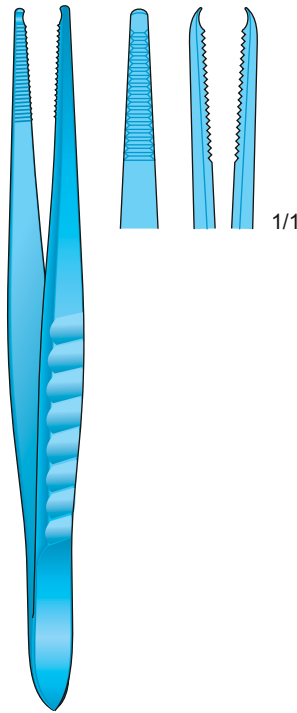

0204-CHA19
130 mm

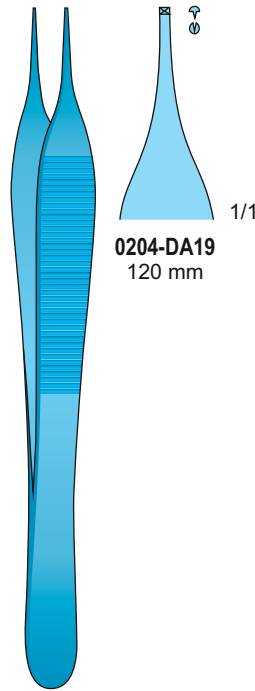

ADSON
0204-DA19
120 mm

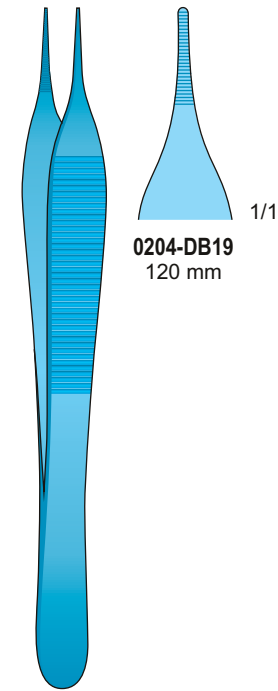

ADSON
0204-DB19
120 mm

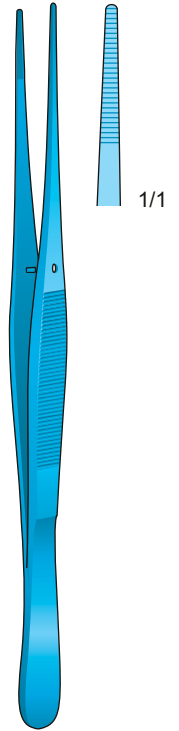

0204-AL19
130 mm

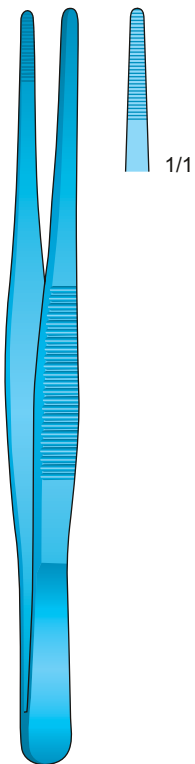

0204-HF19
145 mm

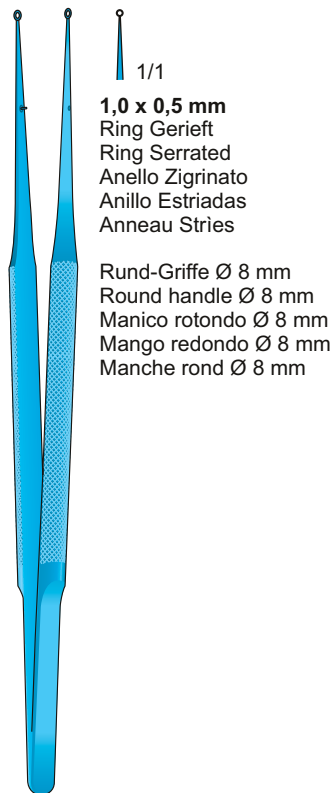

1206-DEC19
150 mm

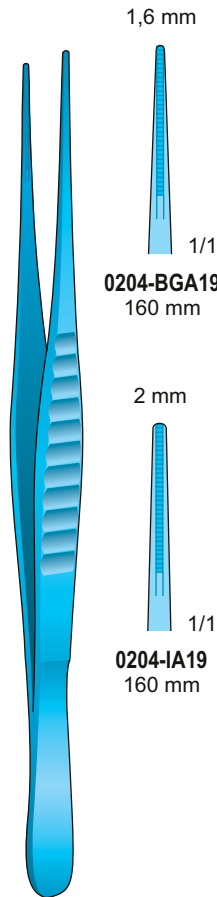

DE BAKEY
0204-IA19/0204-BGA19
160 mm

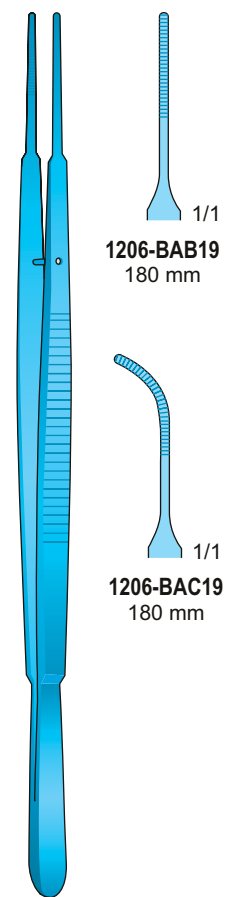

GERALD
1206-BAB19/1206-BAC19
180 mm

1,0 x 0,5 mm
Ring Gerieft
Ring Serrated
Anello Zigrinato
Anillo Estriadas
Anneau Stries

Rund-Griffe Ø 8 mm
Round handle Ø 8 mm
Manico rotondo Ø 8 mm
Mango redondo Ø 8 mm
Manche rond Ø 8 mm

Chirurgische und Anatomische Pinzetten

Tissue Pliers and Dressing forceps

Pinzette chirurgiche e anatomiche

Pinzas quirùrgicas y anatómicas

Pincas quirurgicales et Anatomiques

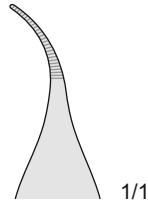

Extra fein
Extra fine
Extra fine
Extra finas
Extra feins

Gebogen
Curved
Curva
Curva
Courbes

MICRO-ADSON
0204-DHC
120 mm

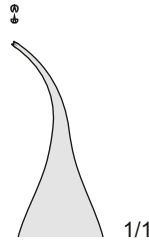

Extra fein
Extra fine
Extra fine
Extra finas
Extra feins

Gebogen
Curved
Curva
Curva
Courbes

1x2 Zähne
1x2 Tooth
1x2 Denti
1x2 Dientes
1x2 Dents

MICRO-ADSON
0204-DHD
120 mm

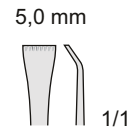
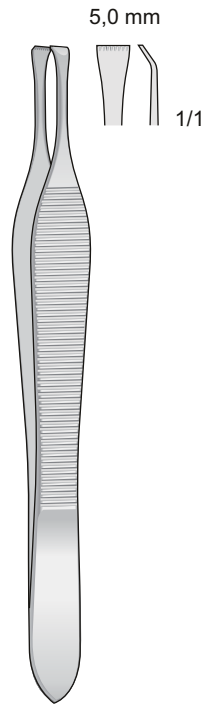

BEASLEY-BABCOCK
0204-FB
120 mm

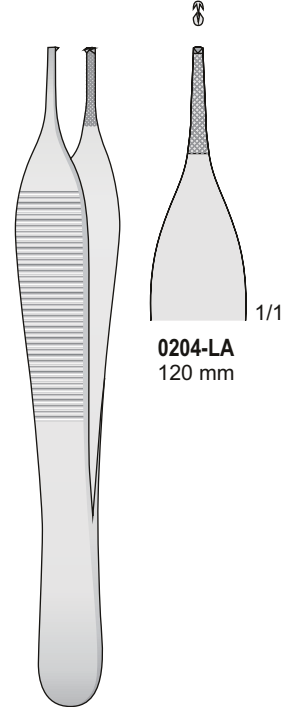

0204-LA
120 mm

ADSON
0204-LA
120 mm

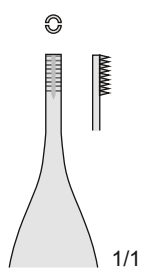
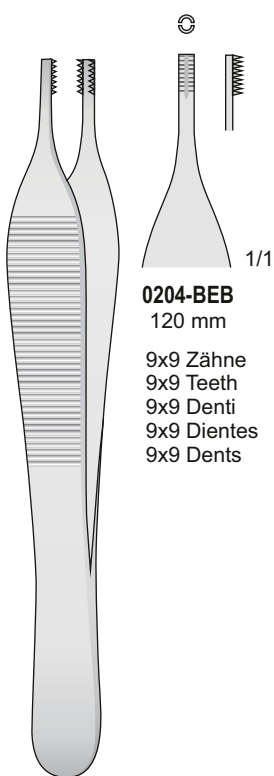

0204-BEB
120 mm
9x9 Zähne
9x9 Teeth
9x9 Denti
9x9 Dientes
9x9 Dents

ADSON-BROWN
0204-BEB
120 mm

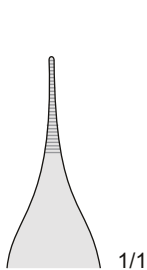
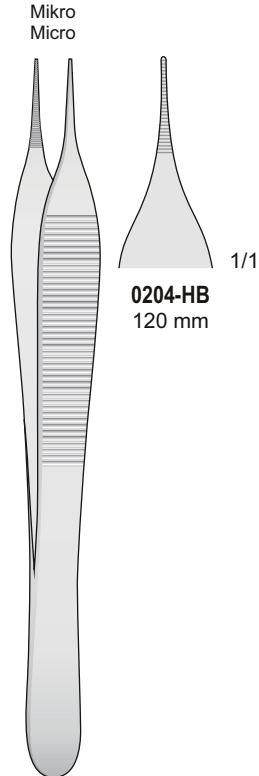

0204-HB
120 mm

ADSON
0204-HB
120 mm

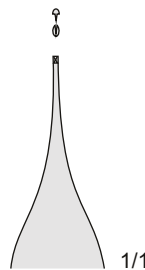
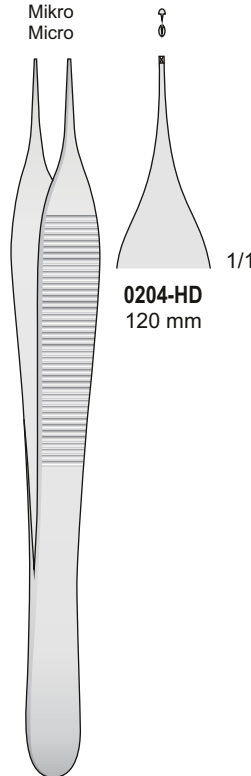

0204-HD
120 mm

ADSON
0204-HD
120 mm

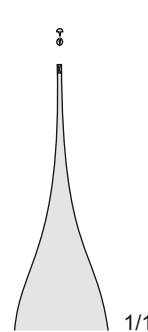
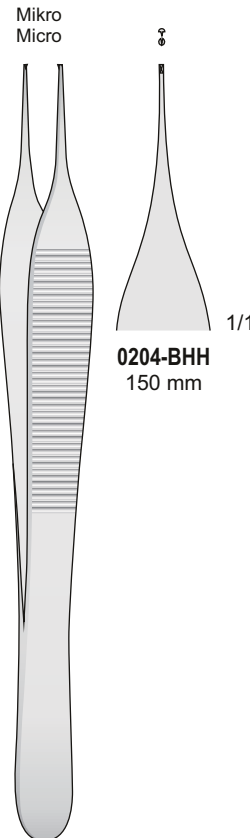

0204-BHH
150 mm

ADSON
0204-BHH
150 mm

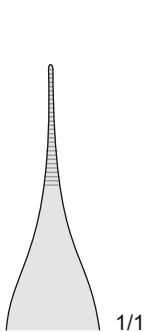
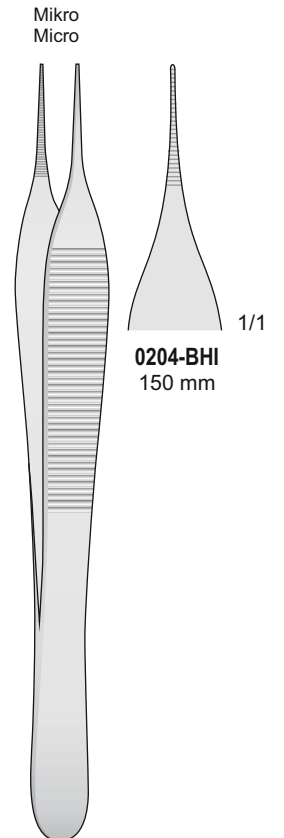

0204-BHI
150 mm

ADSON
0204-BHI
150 mm

Mikro-Chirurgie - Micro Surgical
 Micro Chirurgia - Micro Cirugia
 Micro Chirurgie

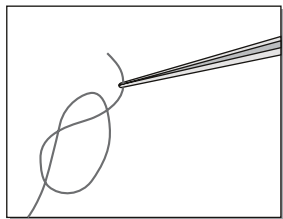

Titan - Titanium
 Titanio - Titane

Rund-Griffe Ø 8 mm - Round handle Ø 8 mm
 Manico rotondo Ø 8 mm - Mango redondo Ø 8 mm
 Manche rond Ø 8 mm

Mikro Nadelhalter
 Micro Needle Holders
 Micro port'aghi
 Micro portaagujas
 Micro porte aiguilles

Mikro Scheren
 Micro Scissors
 Micro forbici
 Micro Tijeras
 Micro ciseaux

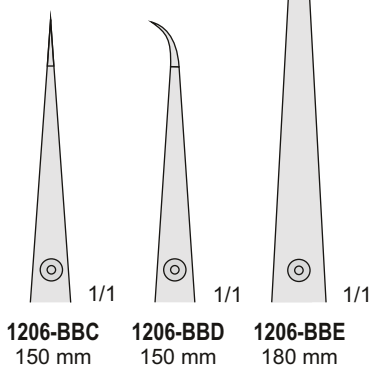
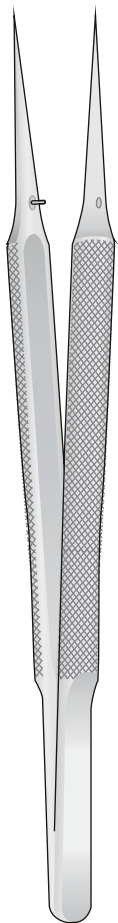

1206-BBC/1206-BBE

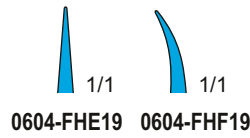
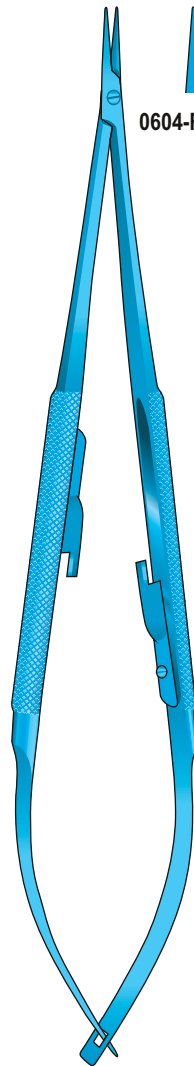

0604-FHE19/0604-FHF19
 180 mm

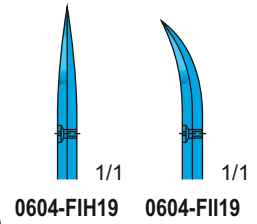
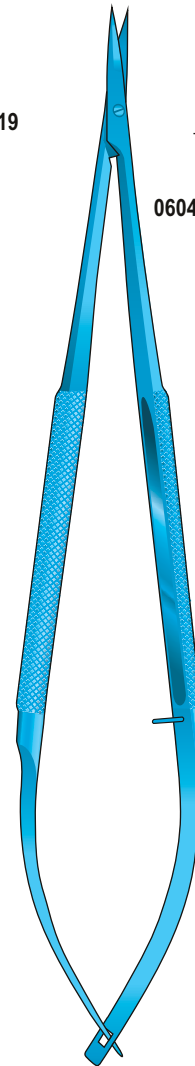

0604-FIH19/0604-FII19
 180 mm

Mikro-Chirurgie - Micro Surgical
 Micro Chirurgia - Micro Cirugia
 Micro Chirurgie

Nadelhalter mit Hartmetalleinlagen
 Needle Holders with tungsten-carbide inserts
 Portaghi con inserti al tungsteno
 Portaagujas con plaquitas de carburo de tungsteno
 Porte aiguilles avec plaquettes en carbure de tungstène

Mit glatten maul
 With smooth jaws
 Con morso liscio
 Con mandibula lisa
 Avec mors lisses

TC

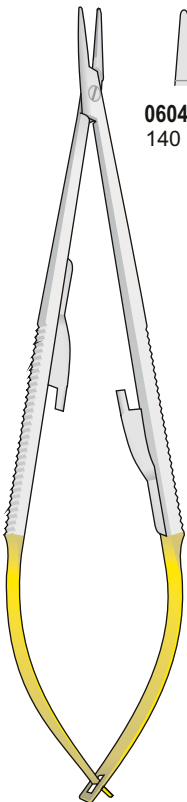

CASTROVIEJO
 0604-CB/0604-CI
 140 mm

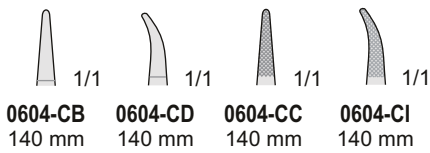

TC

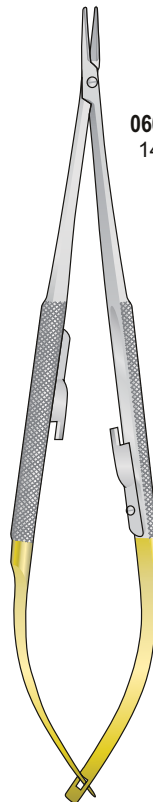

CASTROVIEJO
 0604-BHA/0604-BHB
 140 mm

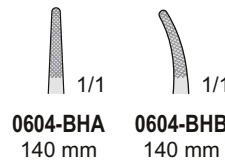

TC

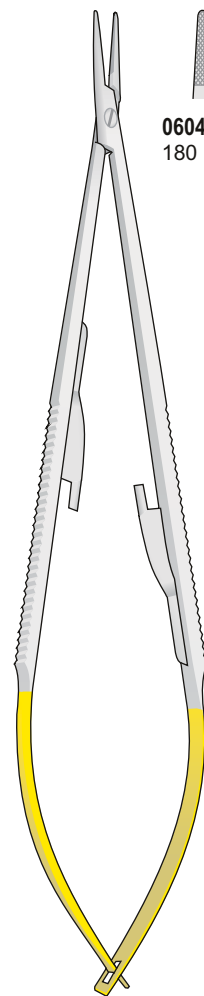

CASTROVIEJO
 0604-CF/0604-CL
 180 mm

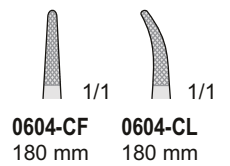

Nadelhalter

Needle holders

Port'aghi

Portaagujas

Porte aiguilles

Nadelhalter mit Hartmetalleinlagen
 Needle Holders with tungsten-carbide inserts
 Portaghi con inserti al tungsteno
 Portaagujas con plaquitas de carburo de tungsteno
 Porte aiguilles avec plaquettes en carbure de tungstène

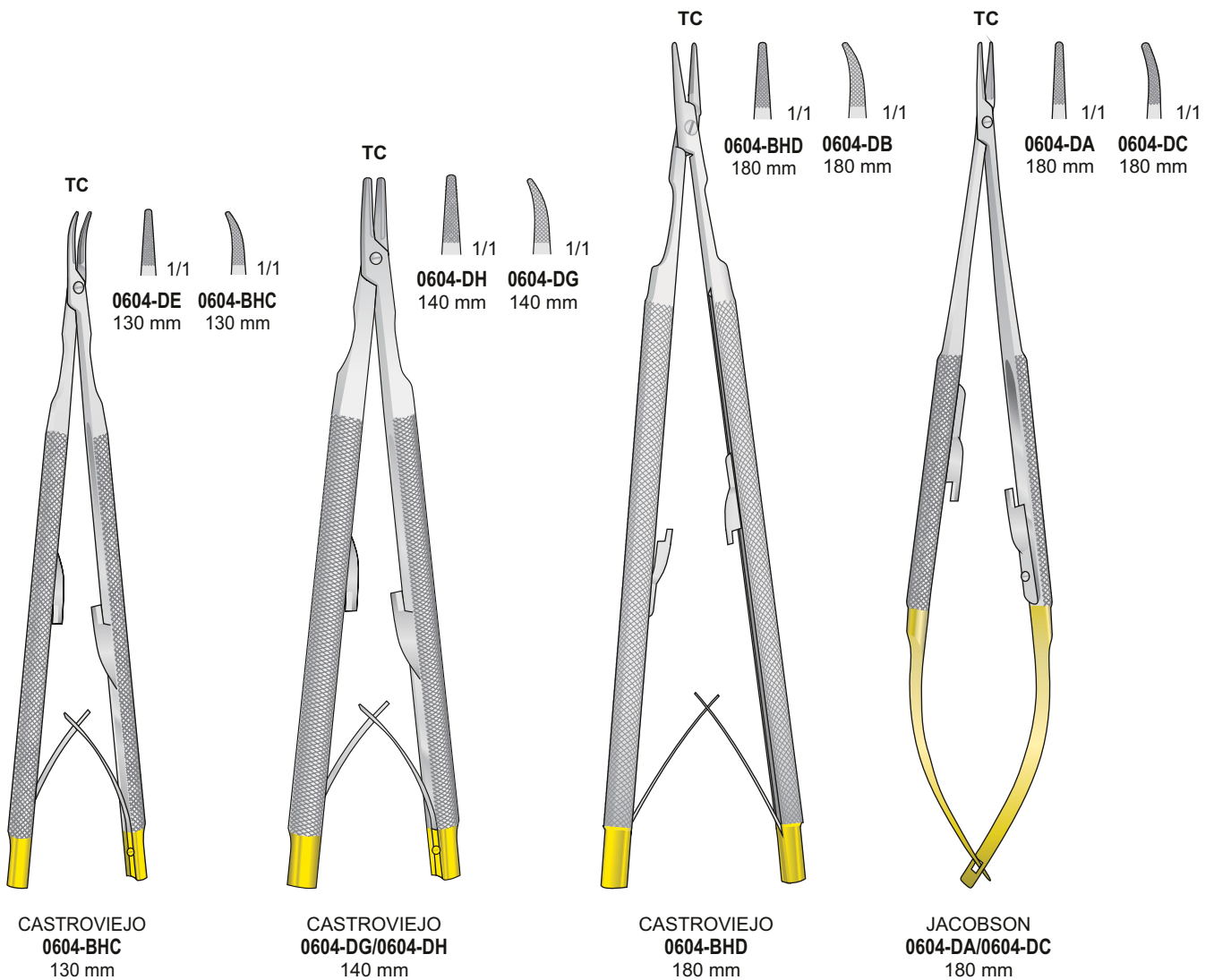

Nadelhalter

Needle holders

Port'aghi

Portaagujas

Porte aiguilles

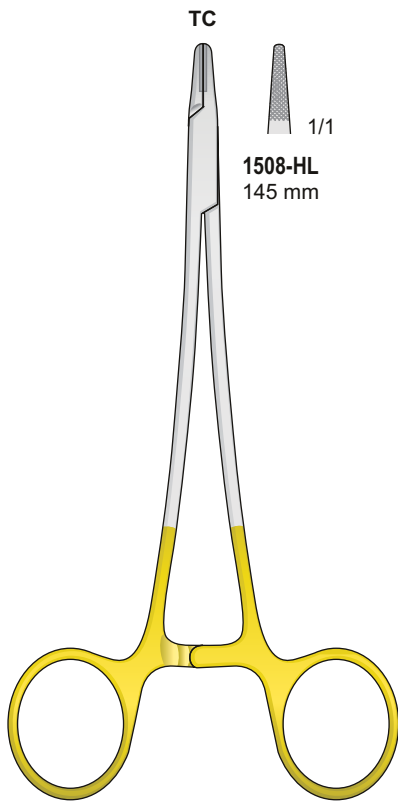

1508-HL
145 mm

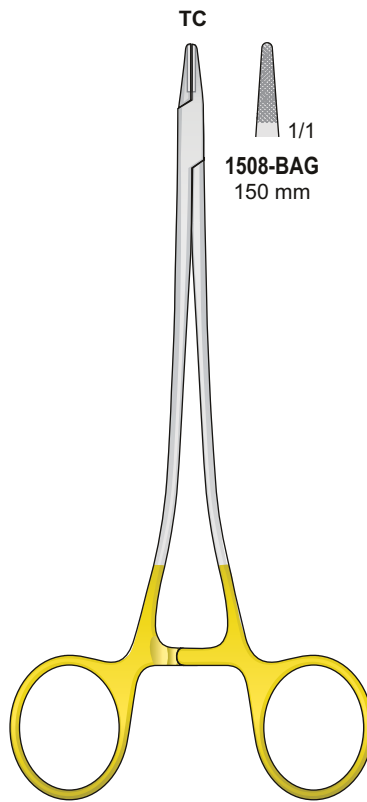

SWEDISH MOD.
1508-BAG
150 mm

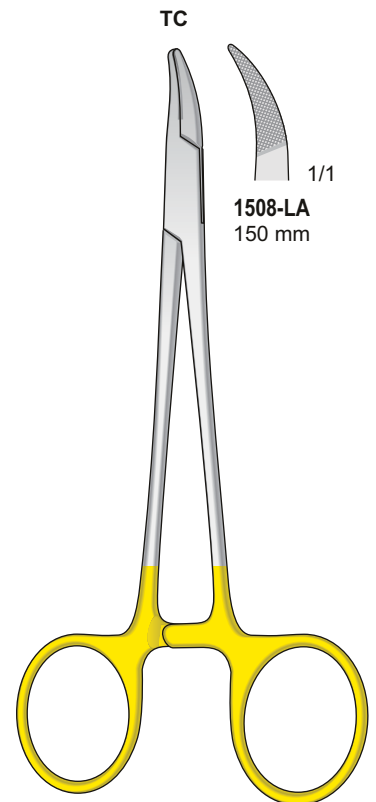

CRILE-WOOD
1508-LA
150 mm

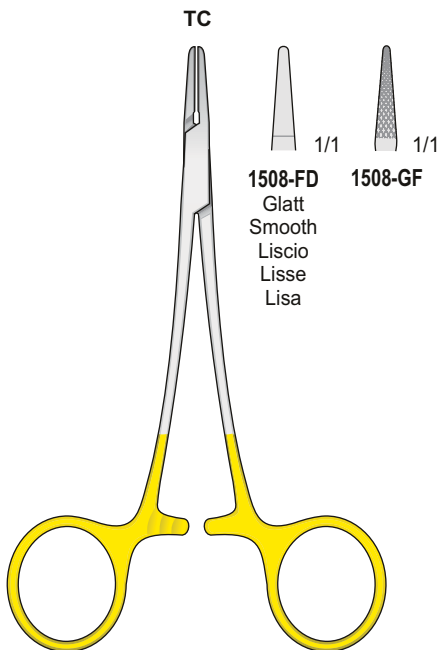

1508-FD/1508-GF
120 mm

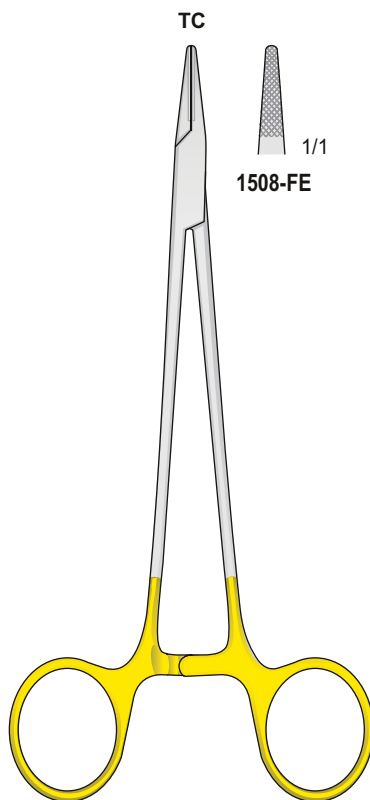

BABY-CRILE-WOOD
1508-FE
150 mm

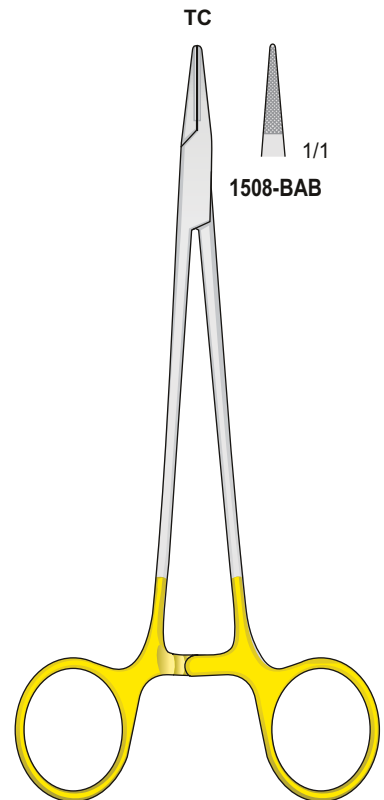

MICRO-VASCULAR
1508-BAB
150 mm

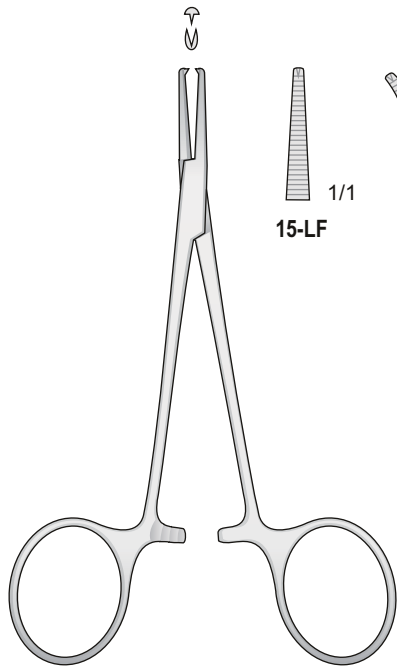

HALSTED-MOSQUITO
15-LF/15-LI
120 mm

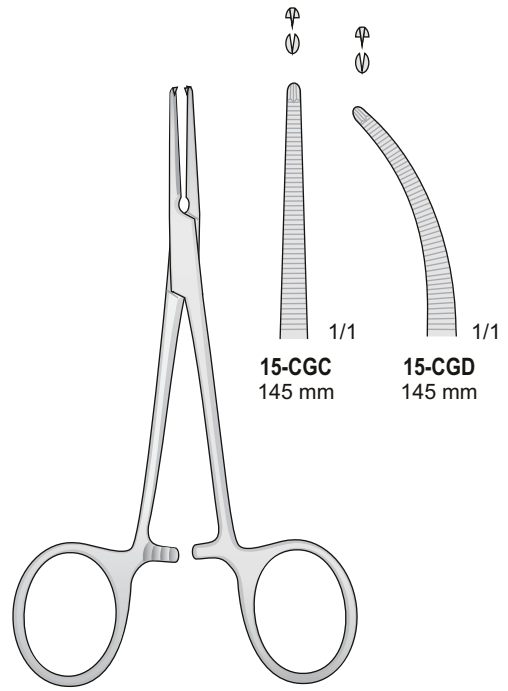

KOCHER
15-CGC/15-CGD
145 mm

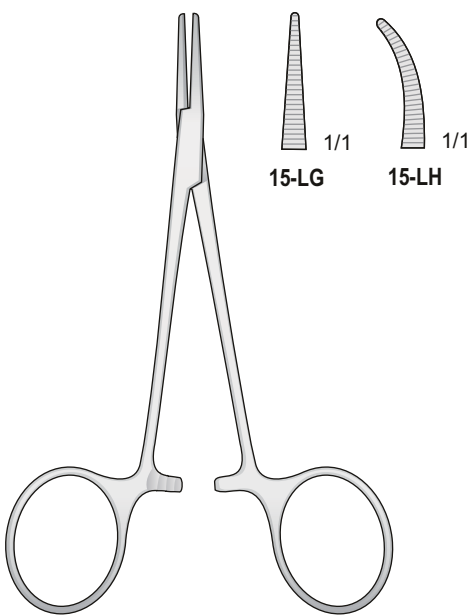

HALSTED-MOSQUITO
15-LG/15-LH
120 mm

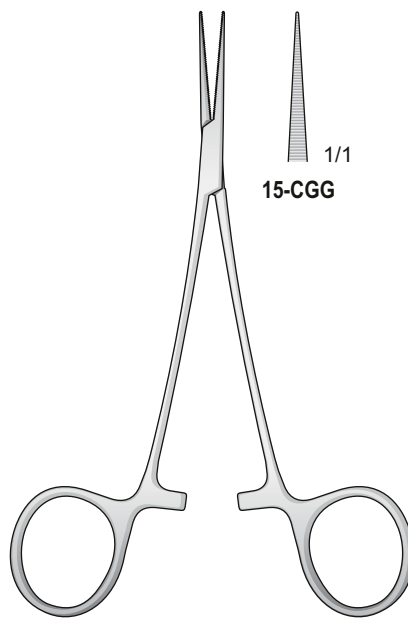

JACOBSON-MICRO
15-CGG
130 mm

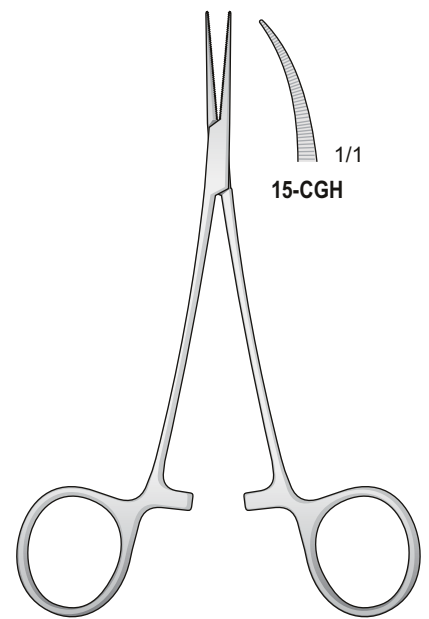

JACOBSON-MICRO
15-CGH
130 mm

Skalpellschlingen
und Skalpellschlingen

Scalpel Blades and
Scalpel handles

Lame per bisturi
Manici per bisturi

Hojas de bisturis
Mangos de bisturis

Lames de bistouris
Manches de bistouris

Steril - Sterile - Sterili - Estériles - Stériles

Fig. 15



1102-BF

Packung 100 Klingen
Package 100 blades
Confezione da 100 lame
Cajita de 100 lames
Boite de 100 lame

Mikro-Klingen - Micro blades
Microlame - Microhojas - Micro lames



1102-DGB



1102-DGC



1102-DGD



1102-DGE



1102-DGH

Packung 10 Klingen
Package 10 blades
Confezione da 10 lame
Cajita de 10 lames
Boite de 10 lame

Rhodium Spiegel
Specchietto rodiato
Espejo de rodio
Miroir au rhodium
Ø 24 mm



1708-F

Packung 12 Spiegel
Package 12 mirrors
Confezione da 12 specchi
Cajita de 12 espejos
Boite de 12 miroirs

Für Mikro-Skalpellschlingen
For Micro Scalpel blades
Per Microlame
Para Microhojas
Pour Micro lames

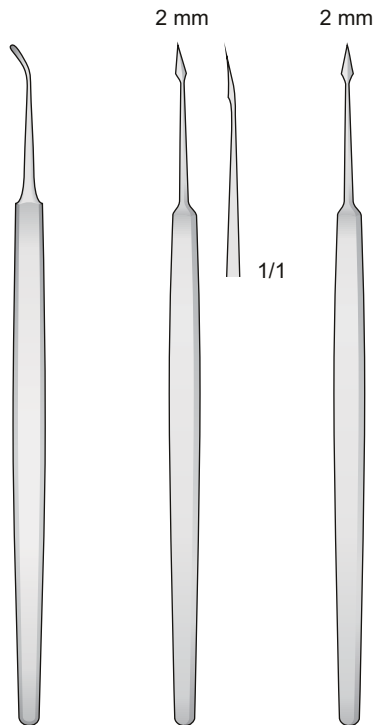

1310-BB
125 mm

1310-BH
125 mm

1310-DL
125 mm



1310-C
150 mm



0202-EG
135 mm



0202-EI
155 mm



1201-02B
Fig. 5



1201-02D12
Fig. 3M

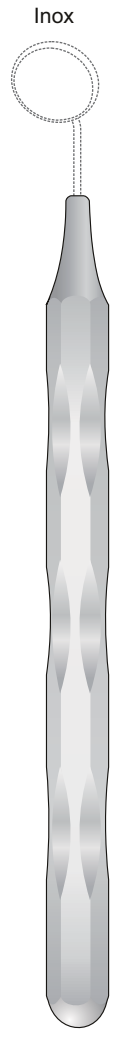

1201-H
135 mm

Mikrochirurgische Spiegel und Halter
 Microsurgical mirrors and holder
 Specchietti per Microchirurgia e manico
 Espejos de microcirugia y mango
 Miroirs de microchirurgie et manche

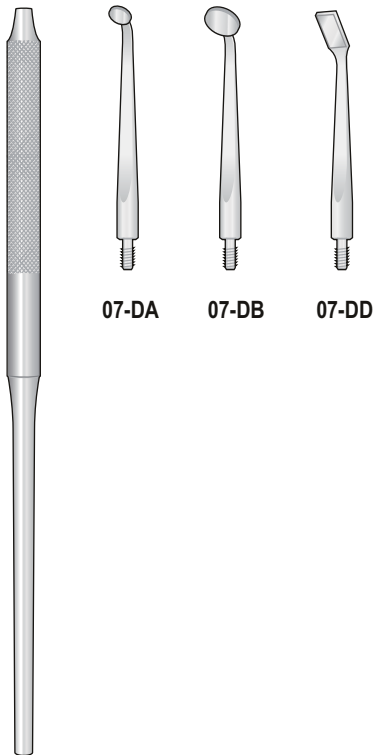

07-DA 07-DB 07-DD

1201-C

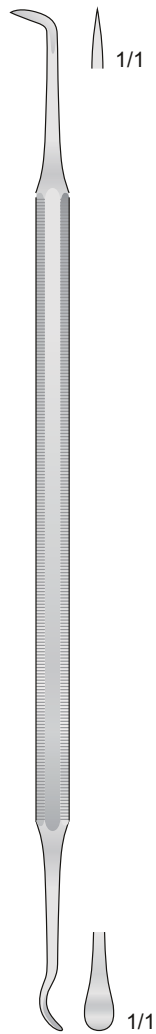

MITCHEL
 0119-BC
 170 mm

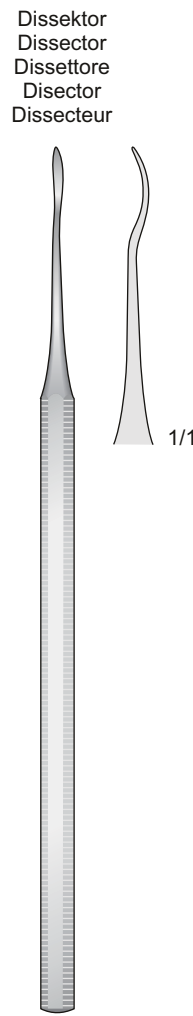

0518-BD
 135 mm

Periotome - Periotomes
 Periotomi - Periostótomos
 Périotomes

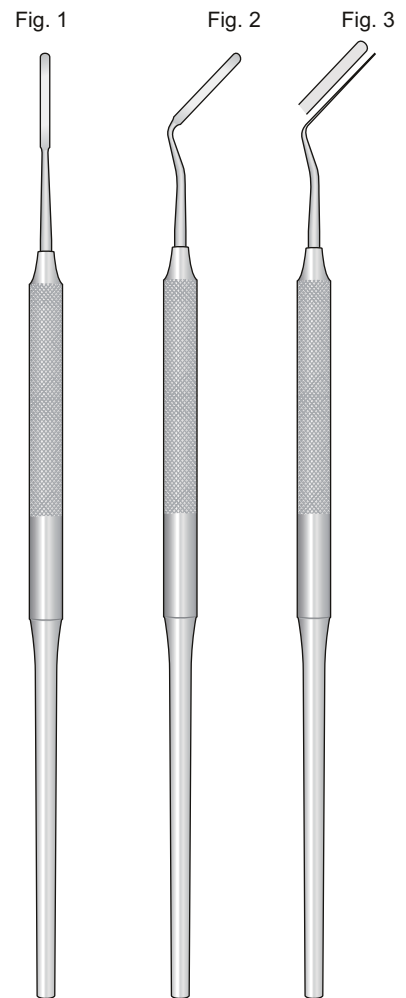

1203-BB 1203-BC 1203-BD
 160 mm 160 mm 160 mm

Meßbereich: 0 - 80 mm
 Measuring range: 0 - 80 mm
 Campo di misura: 0 - 80 mm
 Alcance de medición: 0 - 80 mm
 Etendue de mesure: 0 - 80 mm

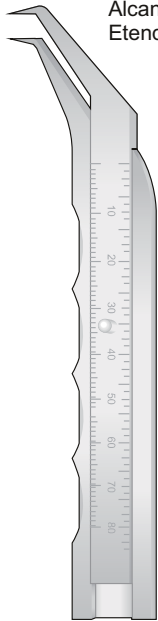

1417-EA
125 mm

0,5 mm



1118-AI
100 mm

0,5 mm



1118-AL
150 mm

Implant Graduierung
 Implant depth gauge with ball end
 Sonda per controllare
 la profondità del sito
 Sonda para controlar
 la profundidad

Ø 2.0 mm



0701-GA
100 mm

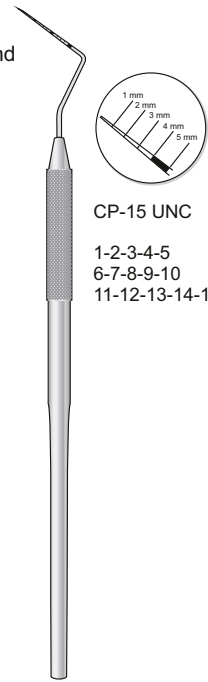

CP-15 UNC

1-2-3-4-5
 6-7-8-9-10
 11-12-13-14-15

1812-BF
155 mm

Meßbereich: 0 - 40 mm
 Measuring range: 0 - 40 mm
 Campo di misura: 0 - 40 mm
 Alcance de medición: 0 - 40 mm
 Etendue de mesure: 0 - 40 mm

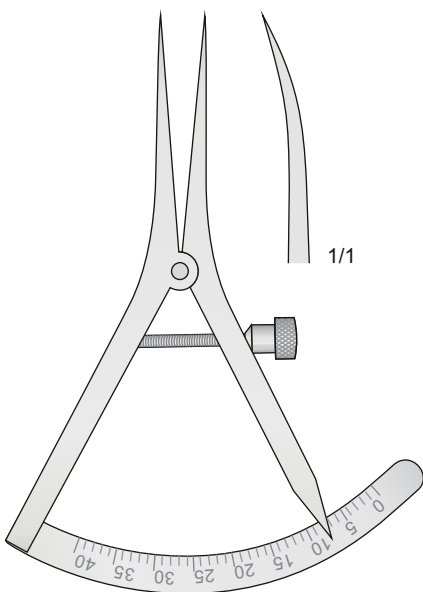

CASTROVIEJO
1417-BD
90 mm

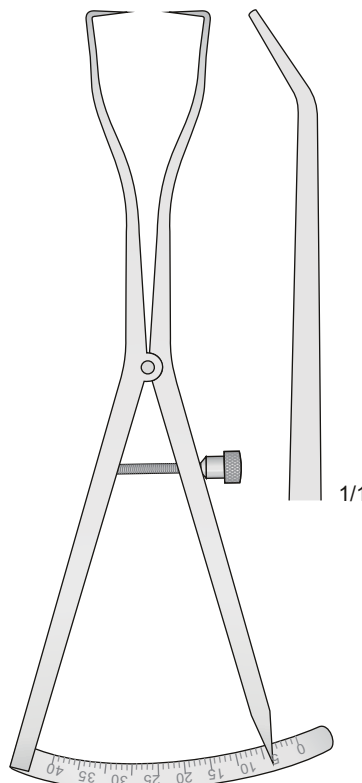

CASTROVIEJO
1417-BI
170 mm

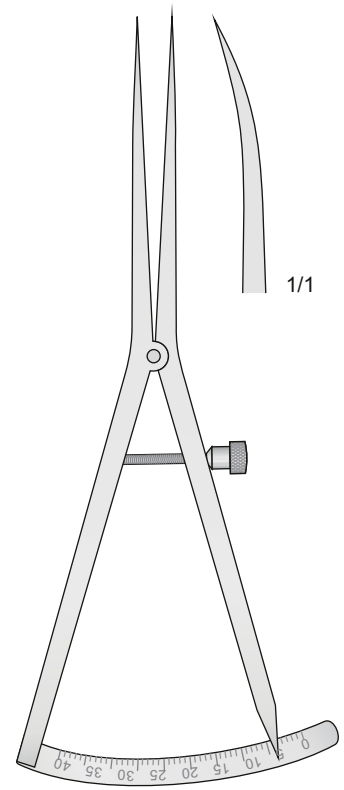

CASTROVIEJO
1417-BE
170 mm

Mundsperrer
Wundhaken

Mouth Gags
Retractors

Apribocca
Divaricatori

Abrebocas
Separadores

Écarteur buccal
Écarteurs

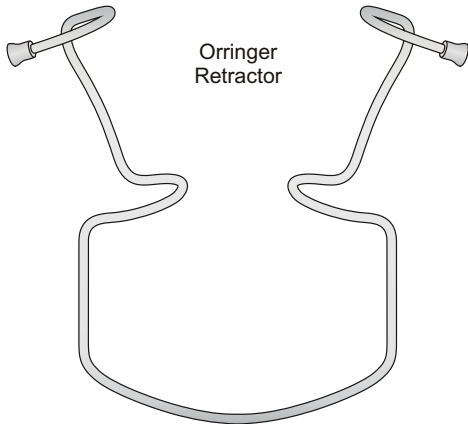
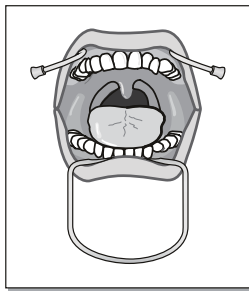

Orringer
Retractor

- 1412-HE** Fig. 0 100 x 95 mm
- 1412-HF** Fig. 1 115 x 105 mm
- 1412-HG** Fig. 2 115 x 110 mm
- 1412-HH** Fig. 3 125 x 115 mm

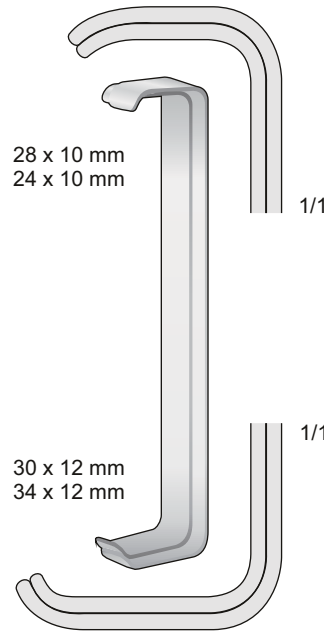

28 x 10 mm
24 x 10 mm

30 x 12 mm
34 x 12 mm

FARABEU
0219-CA
120 mm

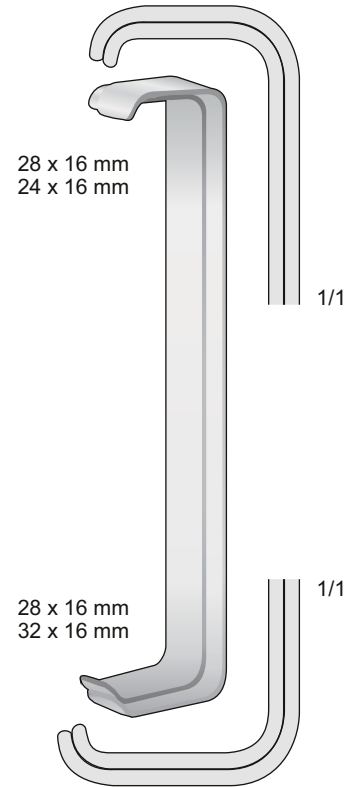

28 x 16 mm
24 x 16 mm

28 x 16 mm
32 x 16 mm

FARABEU
0219-CF
150 mm

Abhalter für gesamten Ober- bzw. Unterkiefer - Retractor for complete upper resp. Lower jaws
Retrattore per arcata superiore e inferiore intera - Separadores para quijadas enteras inferiores y superiores
Écarteurs pour machoires complètes inférieures et supérieures

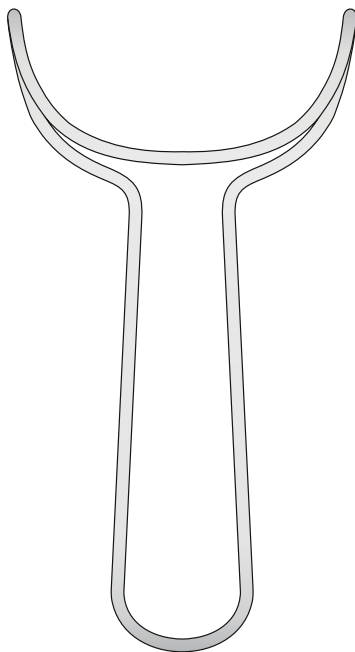

1412-LA
150 mm

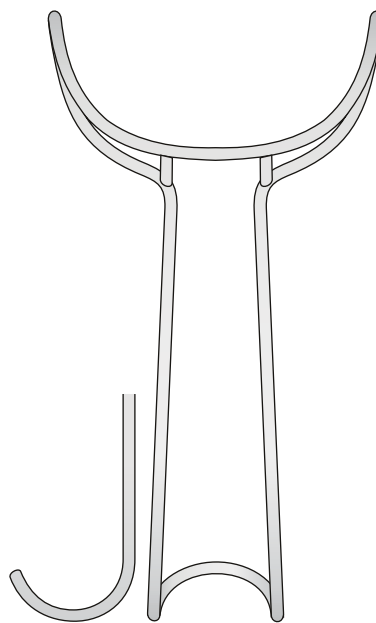

1412-LB
140 mm

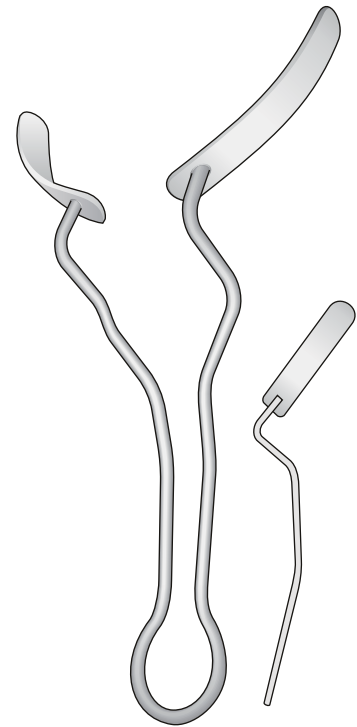

MATY
1412-LH
170 mm

Wangenhalter
Zungenspatel

Cheek Retractors
Tongue depressor

Divaricatori per guance
Abbassalingua

Separadores para mejillas
Abaja lenguas

Écarteurs des joues
Abaisse-langue

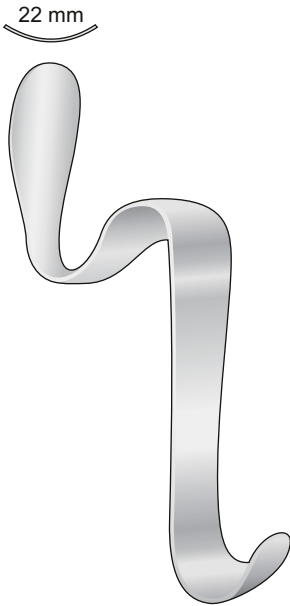

BISHOP
1412-GB
130 mm



MINNESOTA
1412-FF
140 mm

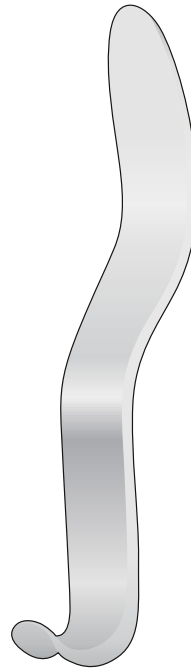

CAWOOD-MINNESOTA
1412-GG
160 mm

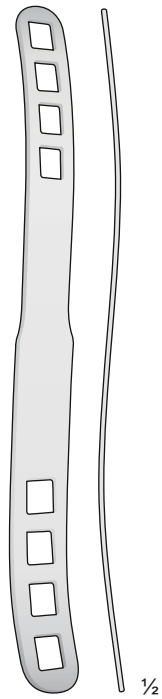

BRUENINGS
1412-AE
190 mm

Rostfrei - Stainless Steel - Acciaio - Acero - Acer
Biegsam - Malleable - Malleabili - Maleables - Malléable

Schwarz Verchromt - Black anodized
Cromato nero - Cromado en negro
Chromé noir



1412-IH
200 mm

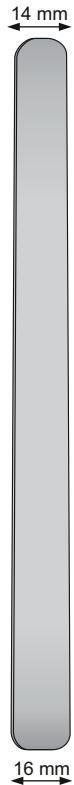

1412-II
200 mm



1412-IA
200 mm



1412-IB
200 mm

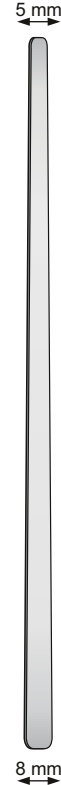

1412-IC
240 mm

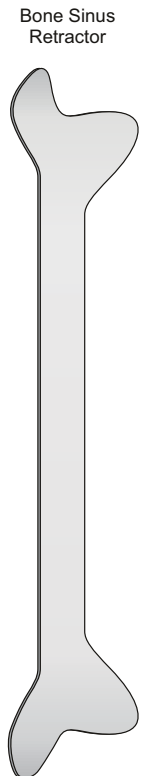

1412-BAA
180 mm

Zubehör
Anaesthésie

Accessories
Anesthesia

Accessori
Anestesia

Accessorios
Anestesia

Accessoires
Anesthésie

Zungen und Wangenhalter
Tongue and Cheek Retractor
Abbassalingua e divaricatore labiale
Retradores de mejillas y labios
Abaisse-langue et ecarteur

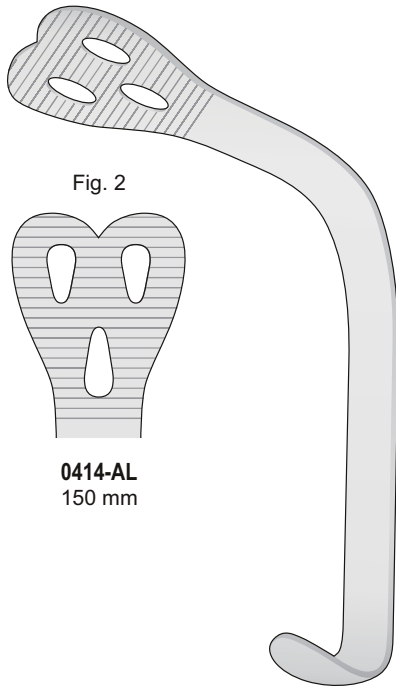
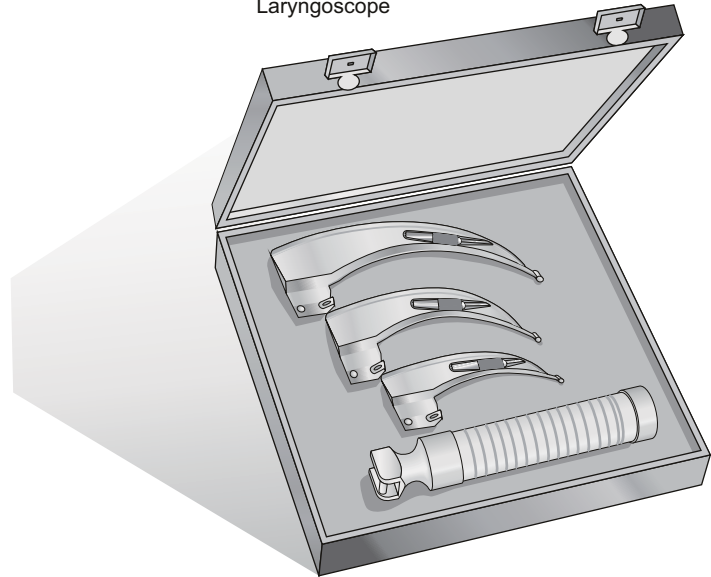

Fig. 2

0414-AL
150 mm

WIEDER
0414-AL
150 mm

Laryngoskop
Laryngoscope
Laringoscopia
Laringoscopia
Laryngoscope



Mc INTOSH
0101-18BAD
Komplett - Complete
Completo - Completo
Completo

Zungenzangen
Tongue holding forceps
Pinza tiralingua
Pinzas tira-lengua
Pince tire-langue

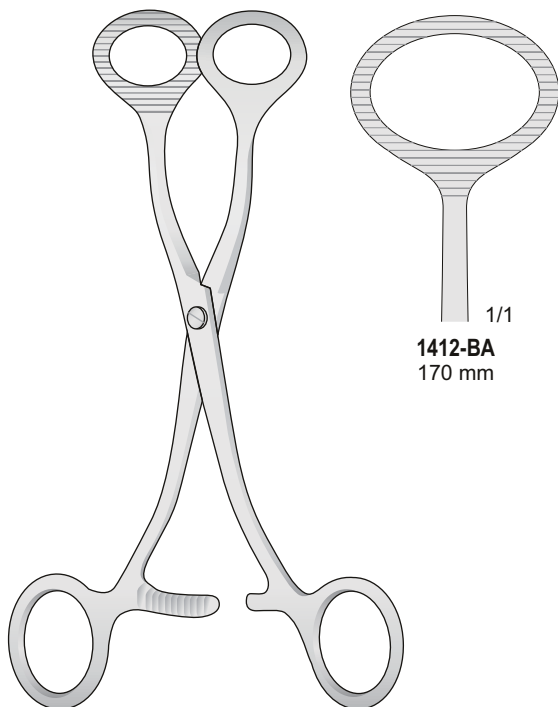

1/1
1412-BA
170 mm

COLLIN
1412-BA
170 mm

Kathetereinführungszangen
Catheter introducing forceps
Pinze da intubazione
Pinzas para introducir catéteres
Pinces pour introduire les sondes

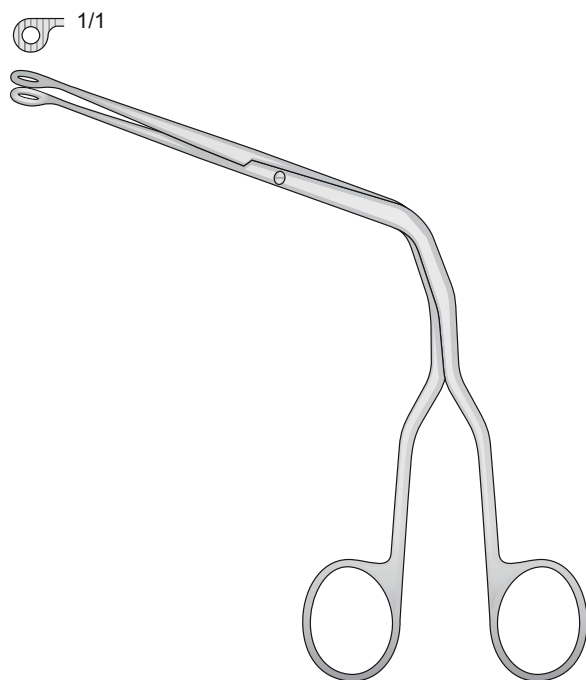

MAGILL
1412-BC
150 mm

Retraktoren

Retractors

Divaricatori

Separadores

Écarteurs

Sinus Lift Retraktoren - Sinus Lift Retractors
 Divaricatori per Sinus Lift - Separadores para Sinus Lift
 Écarteurs pour Sinus Lift

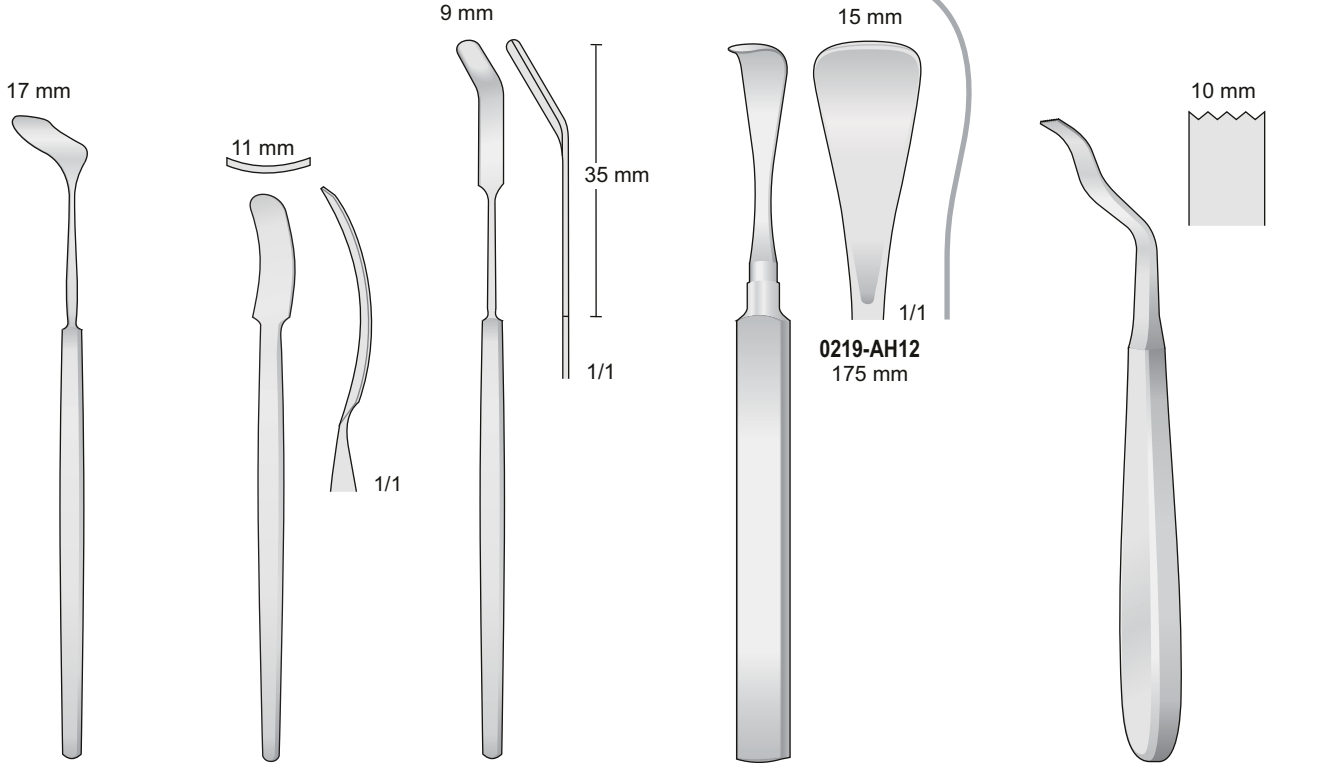

SAUTTER
1310-CEL
145 mm

1310-BAF
125 mm

MODELL GIESSEN
1310-CFB
160 mm

HENAHAN
0219-AH12
175 mm

0414-CAE
170 mm

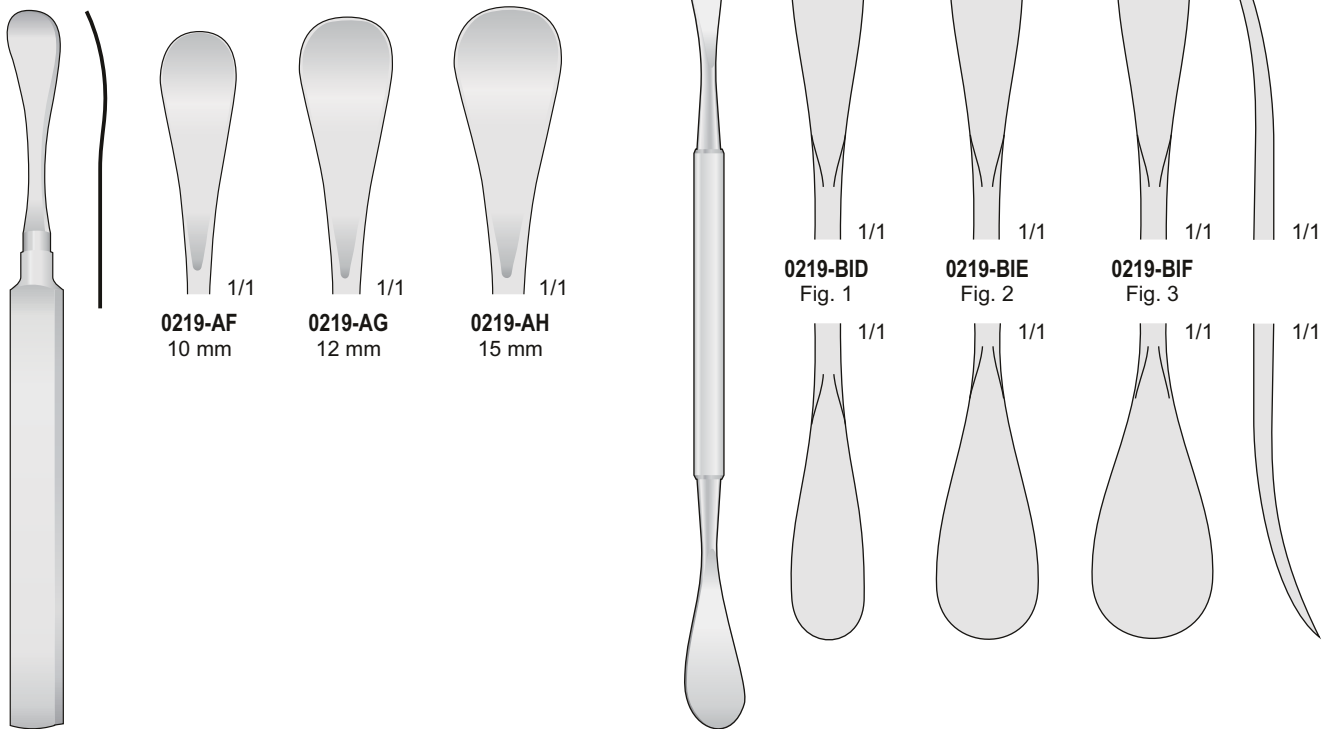

HENAHAN
0219-AF/0219-AH
175 mm

HENAHAN
0219-BID/0219-BIF
200 mm

Wundhaken

Retractors

Divaricatori

Separadores

Écarteurs

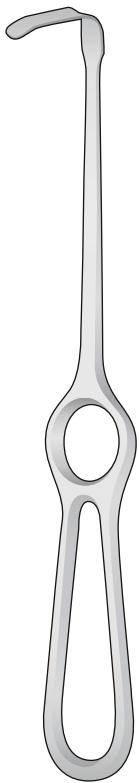

OBWEGESER
0219-LE/0219-BFG
220 mm

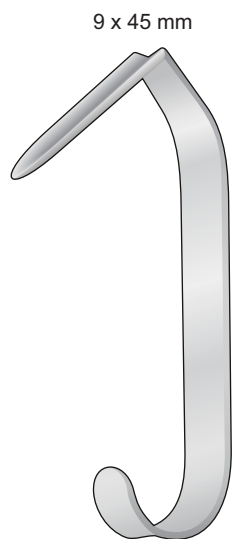
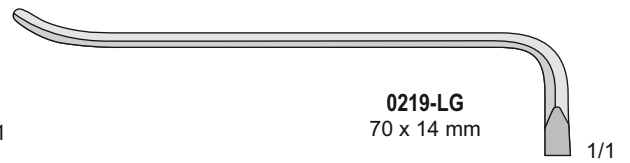
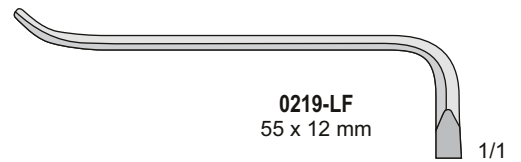
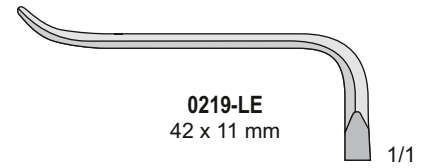
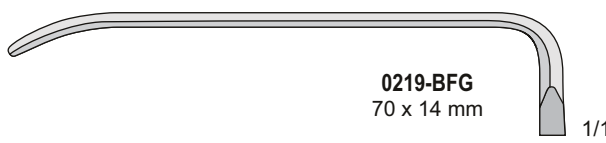
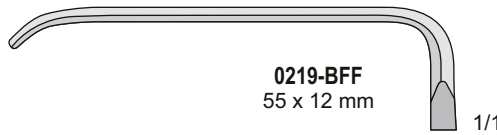
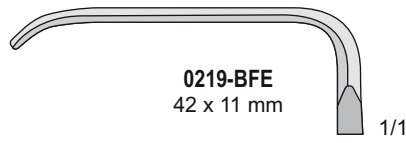

MALINIAC
0414-CAA
100 mm

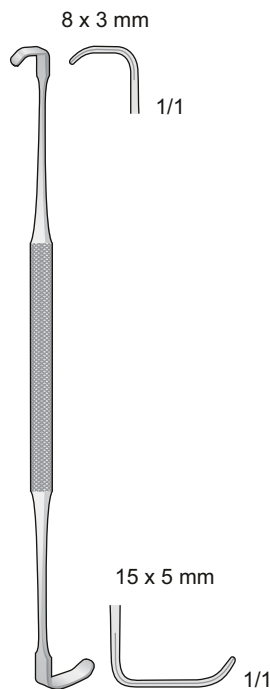

RAGNELL
0219-CH
140 mm

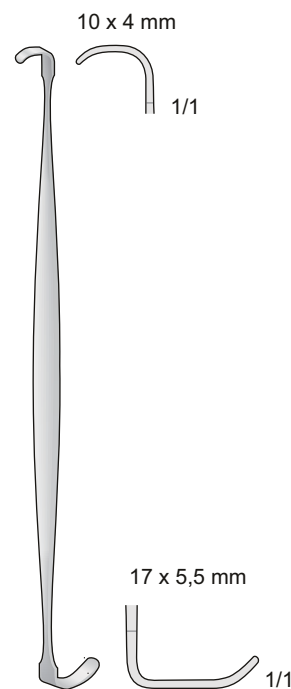

RAGNELL-DAVIS
0219-CG
140 mm

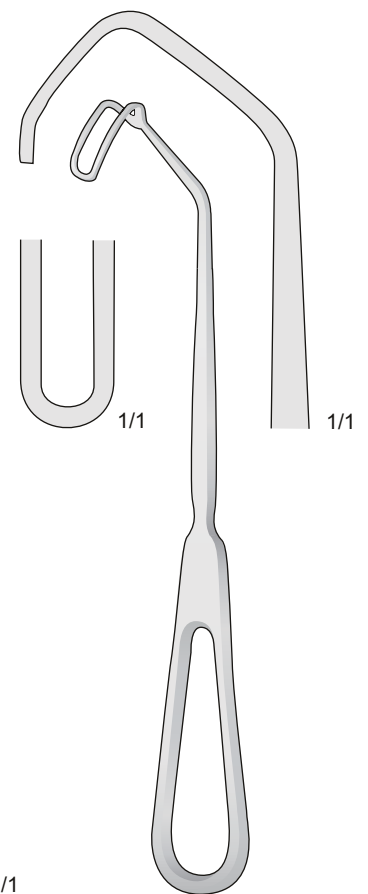

CUSHING
0219-CL
200 mm

Wundspreizer
Knochen-Trephine

Retractors
Bone Trephine

Divaricatori
Trephine per osso

Separadores
Trephin para hueso

Écarteurs
Trephin pour os

Tibia Wundspreizer
Tibial and Iliac Retractor
Divaricatore per tibia e cresta iliaca
Separadores para tibiales y iliacos
Ecarteur pour tibia e crête iliaque

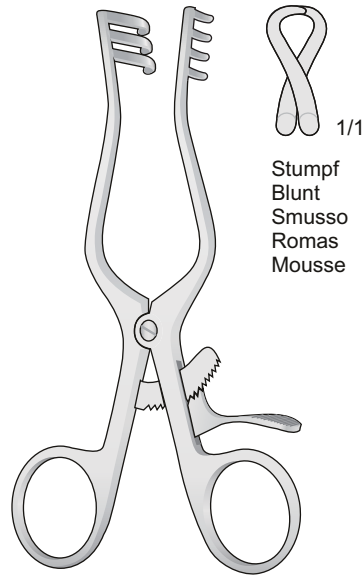

1/1
Stumpf
Blunt
Smusso
Romas
Mousse

WEITLANER
0221-CD
165 mm

0610-BAF

Kompletset mit 4 Teilen - Set complete with 4 pieces
Set completo di 4 pezzi - Set completo con 4 piezas
Set complet avec 4 pièces

Combination Trocar-Trephine Instruments

Bestehend aus einem Trokar, einer gezahnten Trephine und einem Kolben zur Entnahme von Knochentransplantaten aus Tibia und Beckenkamm mittels eines geschlossenen Verfahrens

Consisting of trocar, a toothed trephine and a plunger for taking tibial and iliac bone grafts through a closed technique

Composto di un trequarti, una camicia dentata ed un pistone per il prelievo degli innesti ossei dalla tibia e dalla cresta iliaca tramite una tecnica chirurgica intracutanea

Compuesto por un trócar, un trépano dentado y un émbolo para obtener injertos óseos tibiales e iliacos mediante una técnica cerrada

Composé d'un trocart, d'une tréphine dentée et d'un piston pour le prélèvement de greffes osseuses de la tibia ou de la crête iliaque par une technique fermée

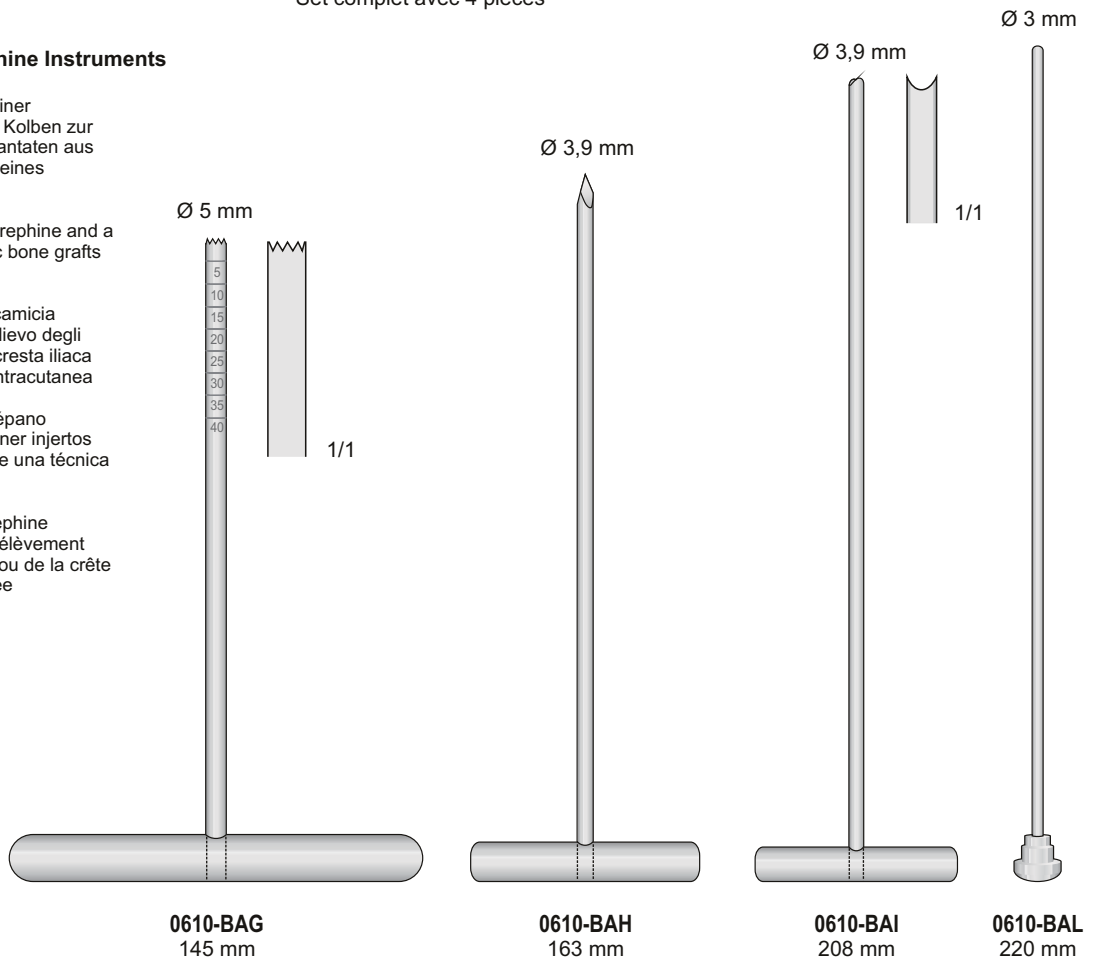

Raspatorien
Elevatorien

Periosteals
Elevators

Scollaperiosteal
Elevatori

Raspadores
Elevadores

Rugines
D colleurs

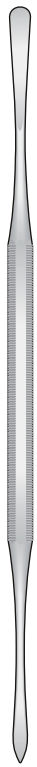

Stumpf
Blunt
Smusso
Mousse
Romo

0518-CH
160 mm



Scharf
Sharp
Tagliente
Tranchant
Cortante

0802
160 mm



**MOLT
HBI-12L**
170 mm



**MOLT
1214-L01**
170 mm

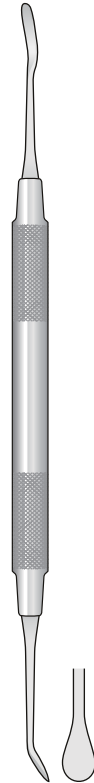

**WOODSON
HBC-CEB**
170 mm

1/1

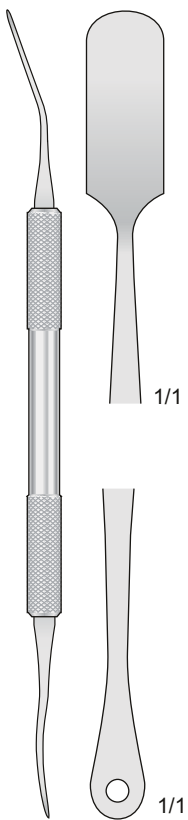

1/1

1/1

**PRICHARD
1517-D01**
180 mm

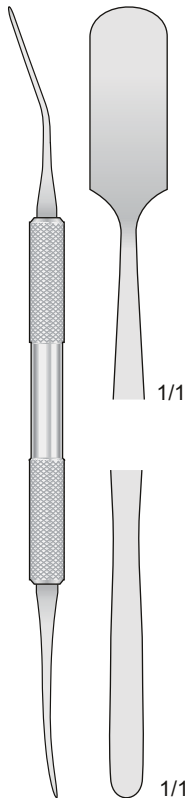

1/1

1/1

**PRICHARD
HBI-1517D**
175 mm

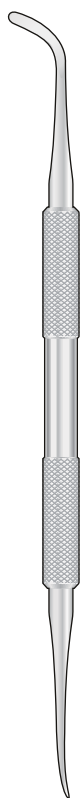
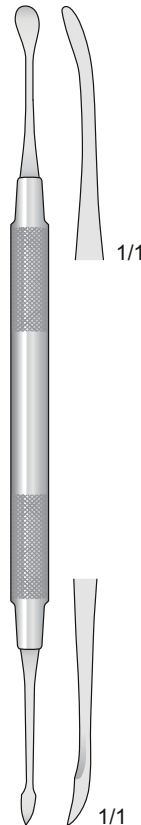

Fig. 12S

**BENNETT
1014-FI**
175 mm



1/1

1/1

**MOLT
1214-I**
185 mm

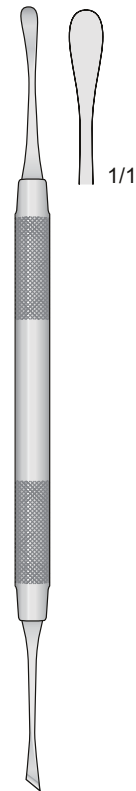

1/1

HBI-CE07
175 mm

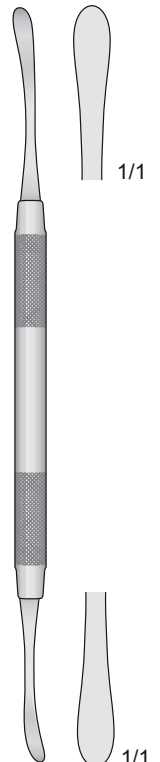

1/1

1/1

**GOLDMAN-FOX
HBI-0706BE**
165 mm

Raspatorien

Periosteals

Scollaperiosteal

Periostotomos - Legras

Rugines à périostomie

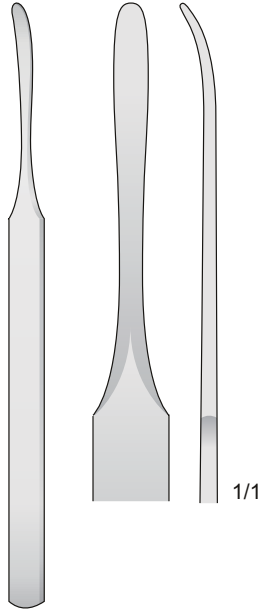

**KÖNIG
1014-B**
155 mm

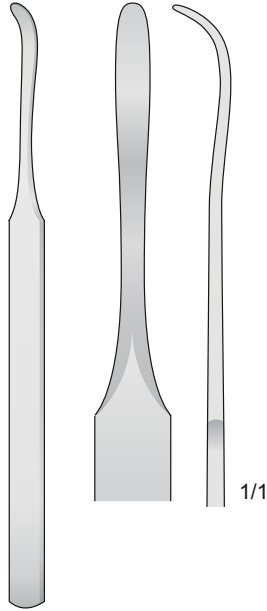

**KÖNIG
1014-C**
155 mm

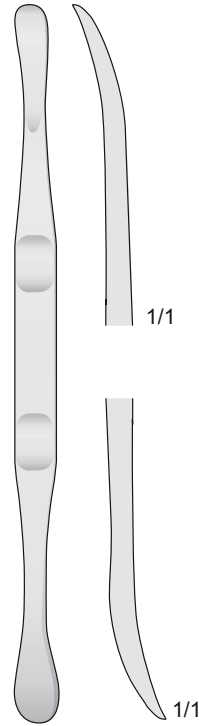

**BABBUSH
1014-CA**
180 mm

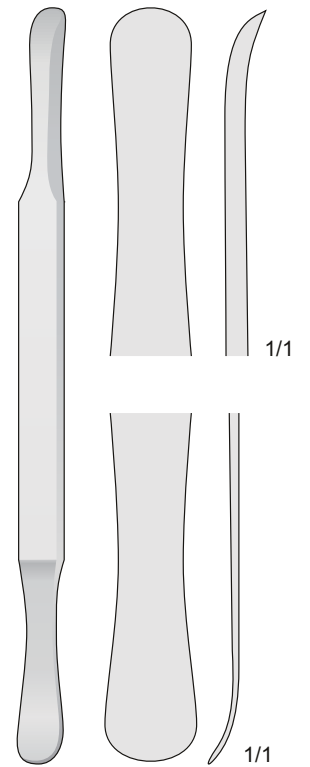

**SELDIN
1014-CD**
195 mm

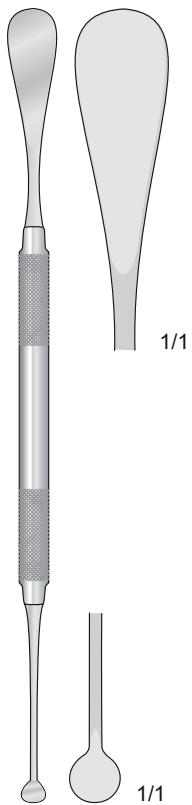

1214-CA
200 mm

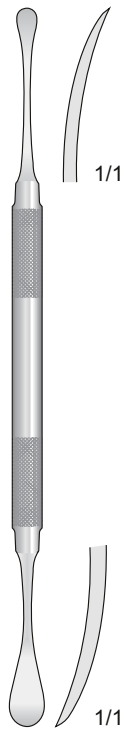

**MENEGHINI
1214-CE**
180 mm

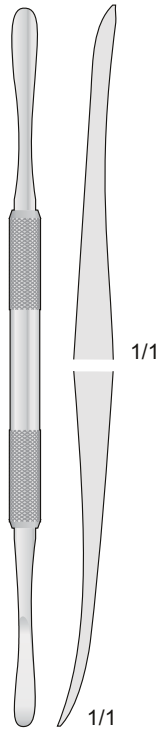

HBI-121
185 mm

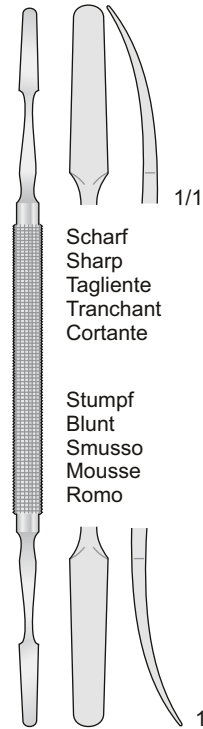

**KILIAN
1014-BB**
180 mm

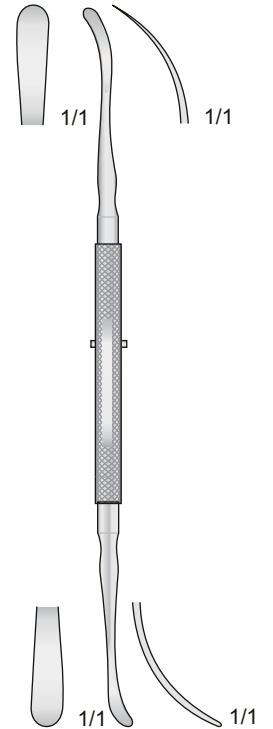

**ROGER
1014-GG**
180 mm

Scharf
Sharp
Tagliente
Tranchant
Cortante

Stumpf
Blunt
Smusso
Mousse
Romo

Raspatorien

Periosteals

Scollaperiosteal

Periostotomos

Raspatoires

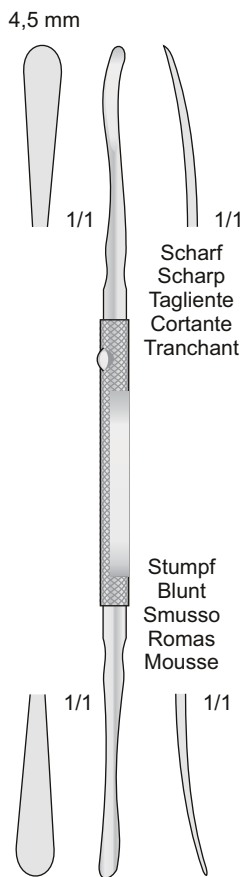

0617050517
180 mm

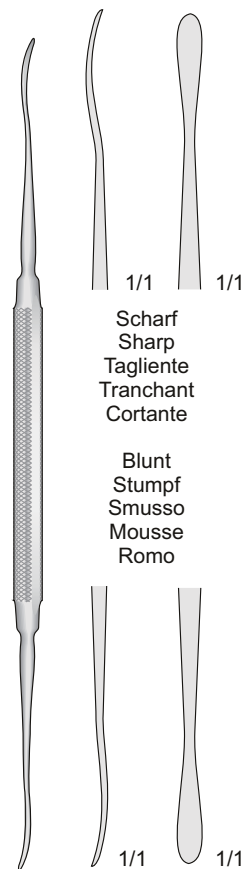

FREER
0617-BG
185 mm

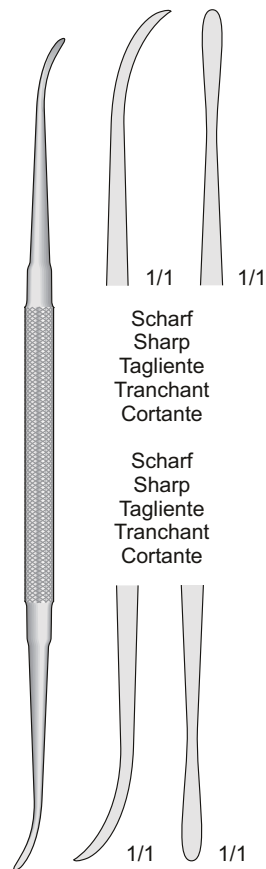

FREER-YASARGIL
0617-BH
185 mm

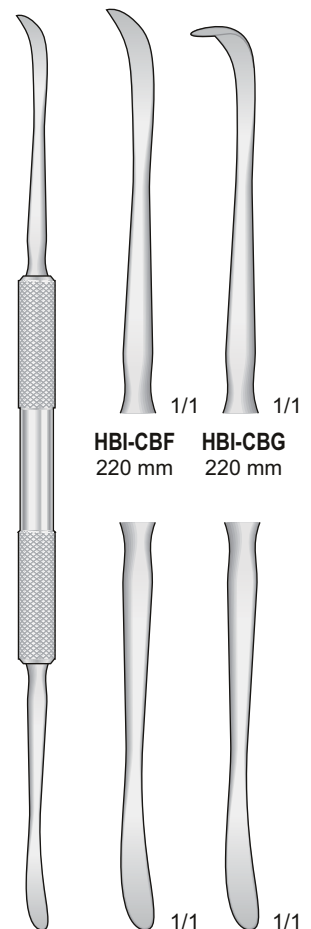

FREER
HBI-CBF/HBI-CBG
220 mm

**Elevatorii
Raspatorii**

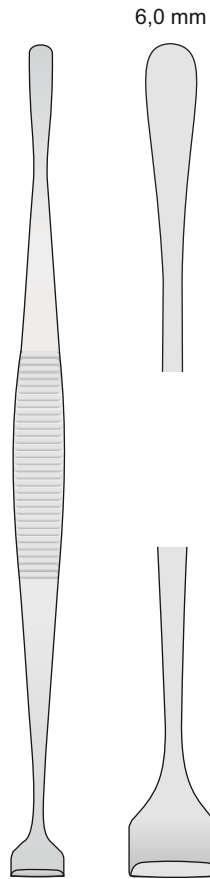

**HURD
0219-B/0219-C
220 mm**

**Elevatorii
Periosteali**

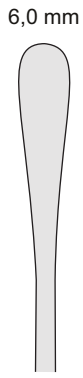

1/1

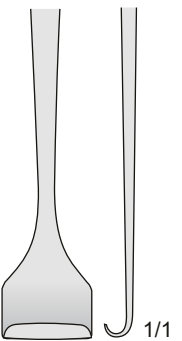

12 mm

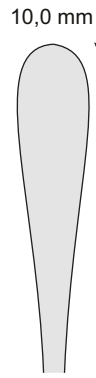

1/1

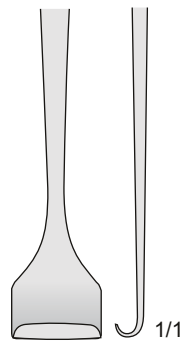

12 mm

**Elevatorii
Scollaperiosteali**

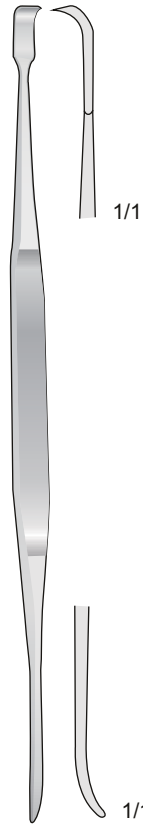

**HOWARTH
1014-DA
210 mm**

**Elevatorii
Periostotomos**

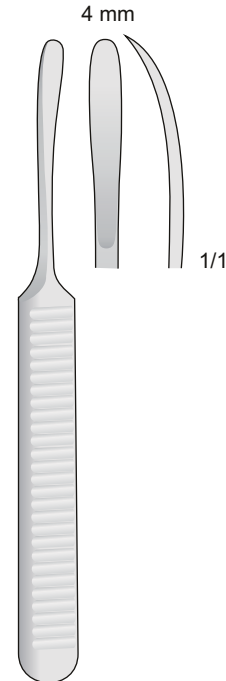

1/1

**WILLIGER
2207-BE
140 mm**

**Élevateurs
Rugines à périostomie**

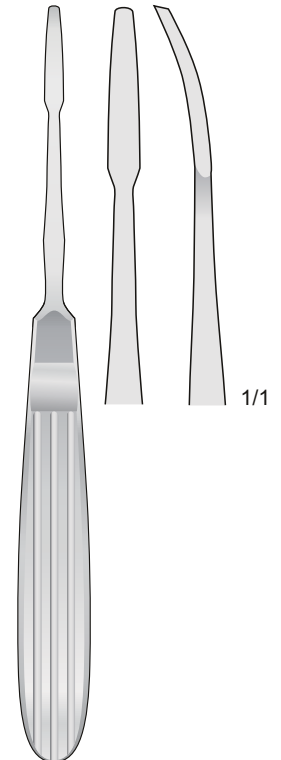

**JOSEPH
0610-IA
170 mm**

6 mm

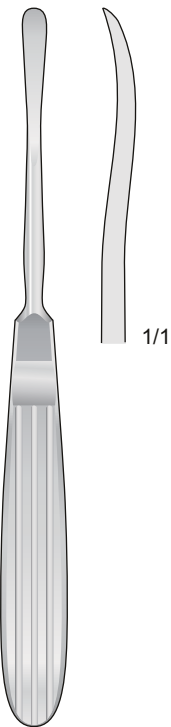

**OBWEGESER
0414-FL
175 mm**

7 mm

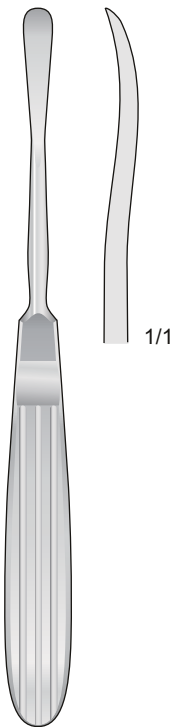

**OBWEGESER
0414-GD
175 mm**

9 mm

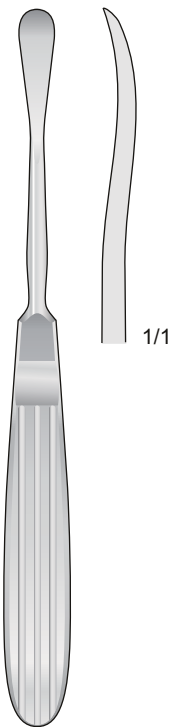

**OBWEGESER
0414-GH
175 mm**

11 mm

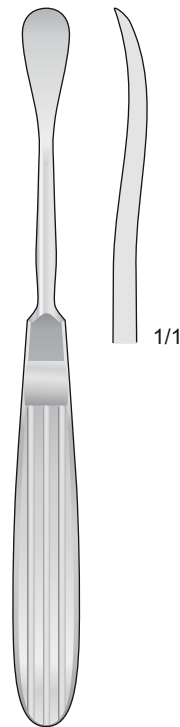

**OBWEGESER
0414-GF
175 mm**

10 mm



**MOLT
1214-BF
160 mm**

Scharfe Löffel

Sharp currettes

Curette, Cucchiari taglienti

Cucharillas cortantes

Curettes tranchantes

4,5 mm

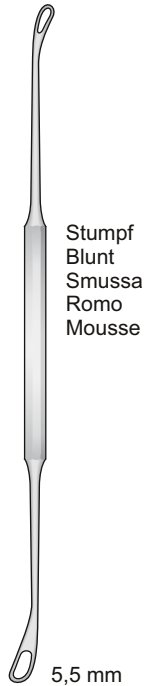

Stumpf
Blunt
Smussa
Romo
Mousse

COXETER
0402-FC
150 mm

1,0 mm/1,2 mm



Leicht Gebogen
Slightly angled
Leggermente
angolata
Ligeramente
acodadas
Légèrement
coudées

HOUSE
0617-BGA
150 mm

1,0 mm/1,2 mm

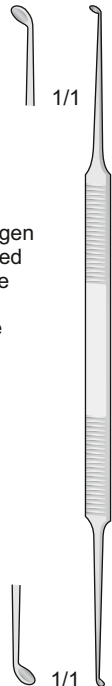

Stark Gebogen
Strongly angled
Fortemente
angolata
Fuertemente
acodadas
Fortement
coudées

HOUSE
0617-BGC
150 mm

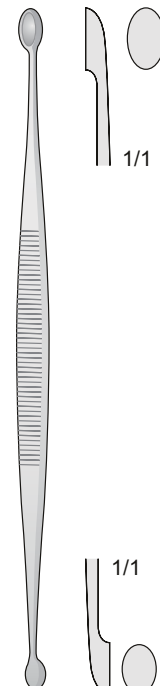

JACOBSON
0610-HF
140 mm

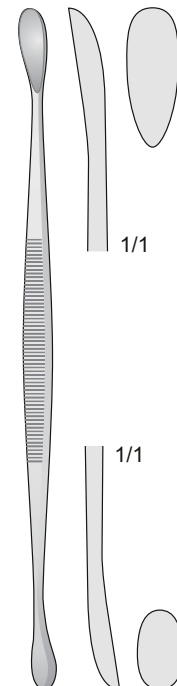

VOLKMANN
0610-HC
145 mm

Surgical Curette

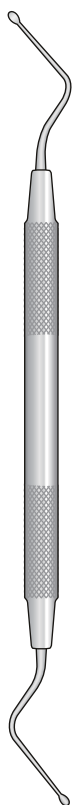

LUCAS
HCA-IF/HCA-IH
180 mm



HCA-IF
180 mm



HCA-IG
180 mm



HCA-IH
180 mm



HCA-II
180 mm

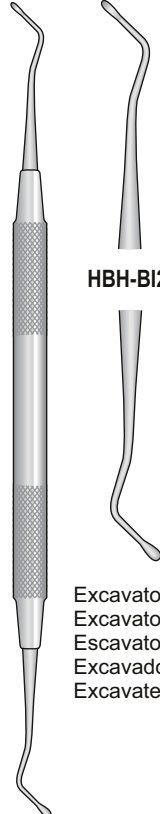

HBH-BI22

Excavator
Excavator
Escavatore
Excavadore
Excavateurs

HBH-BI22



Universal Kürette
Universal Curette
Cureta universale
Curette universelle

Stumpf
Blunt
Smussa
Romas
Mousse

HBI-12CD01
165 mm

Elevatori

Elevators

Elevatori

Elevador

Élévateurs

Sinus Lift Instrumente - Sinus Lift Instruments
 Strumenti per rialzo del seno - Instrumentos para elevación de senos
 Instruments pour les soulevés de sinus

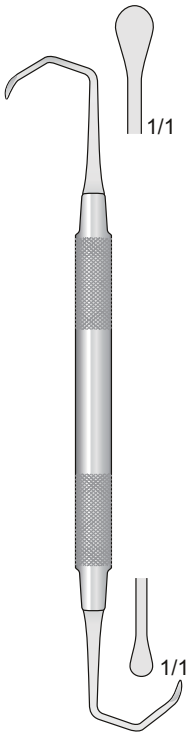

0513-12B
160 mm



0513-12C
160 mm

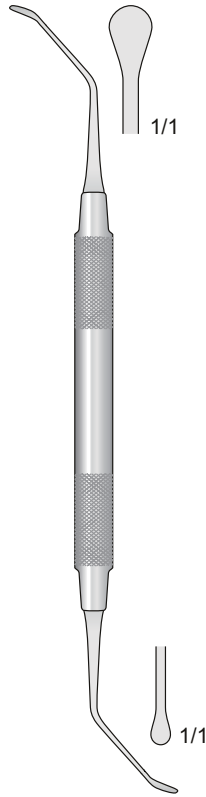

0513-12D
180 mm

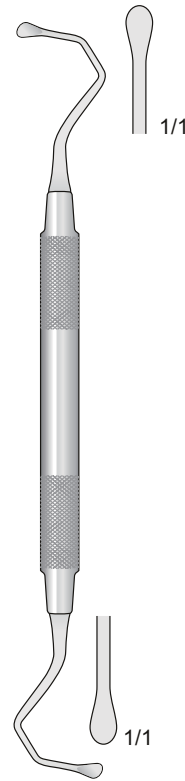

0513-12E
170 mm

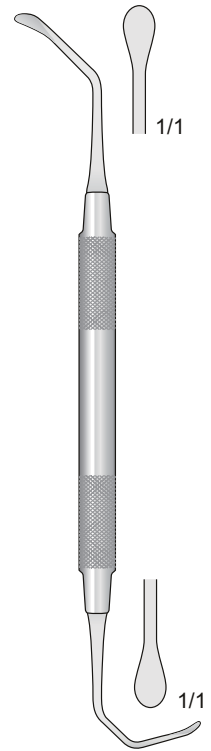

0513-12F
175 mm

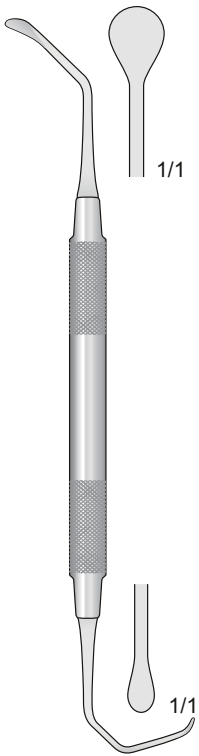

0513-12G
175 mm

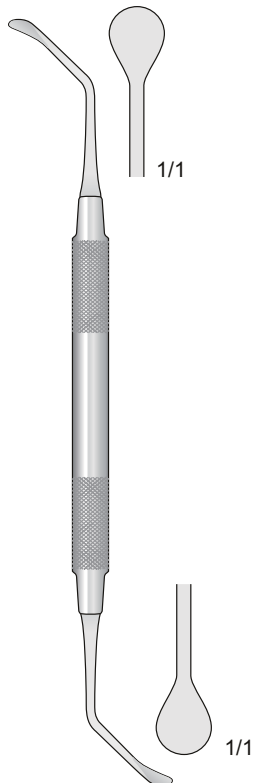

0513-12H
180 mm

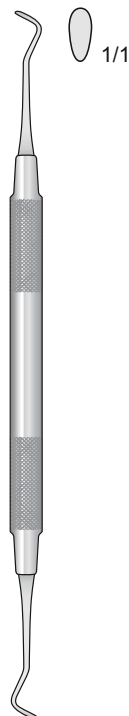

HBI-0513B
175 mm

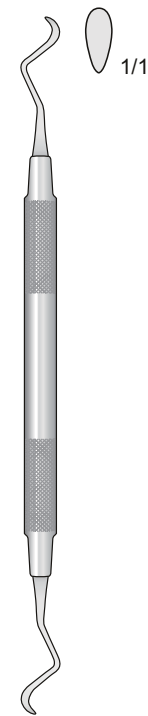

HBI-0513C
165 mm



HBI-0513D
170 mm

Küretten

Curettes

Curette

Curetas

Curettes

Sinus Lift Instrumente
 Sinus Lift Instruments
 Strumenti per rialzo del seno
 Instrumentos para elevación de senos
 Instruments pour les soulevés de sinus

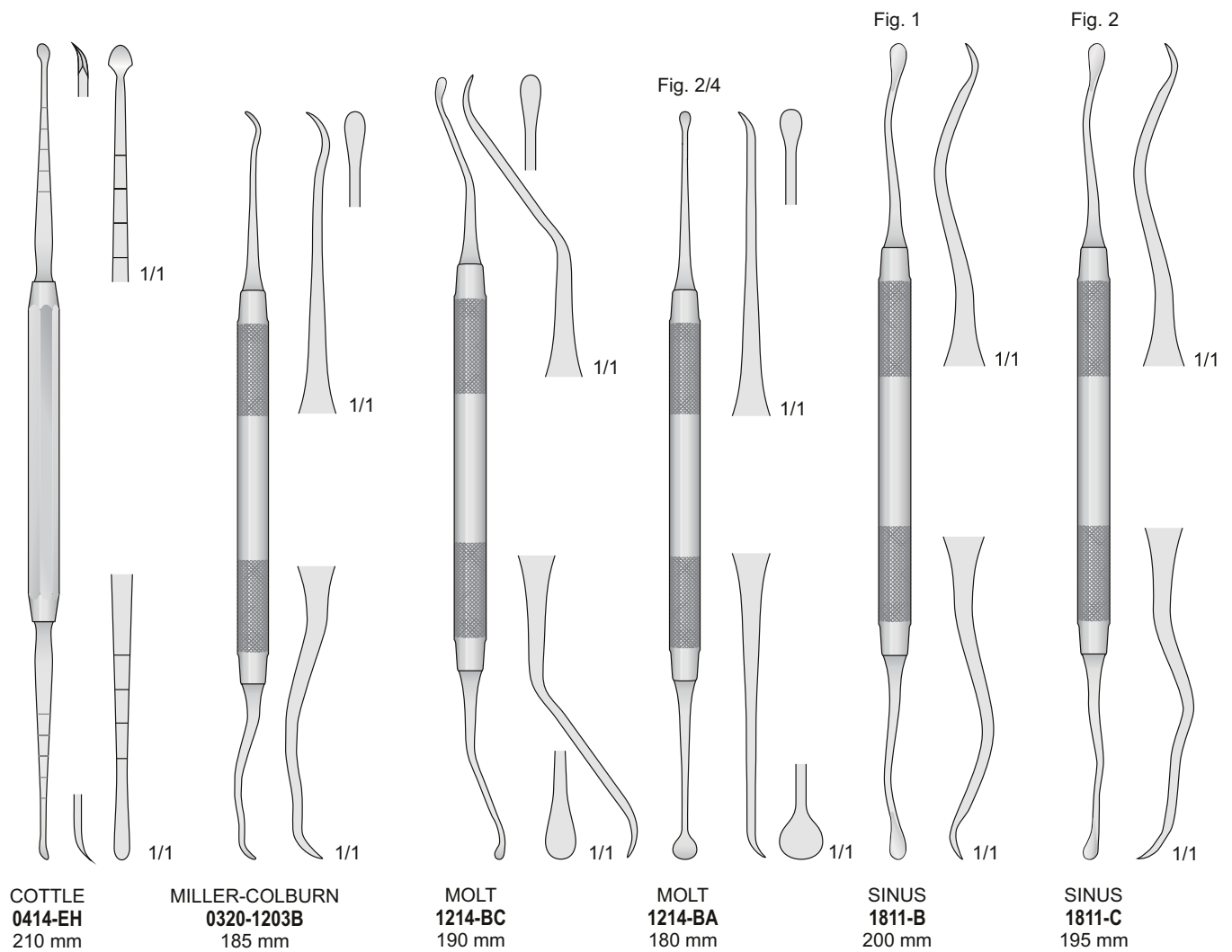

Knochen-Stopfer
Scharfe Löffel

Bone Compactor
Scharp curettes

Compattatori per osso
Cucchiai taglienti

Compactador de huesos
Cucharillas cortantes

Compactateur des os
Curettes tranchantes

Knochenmateriallöffel
Bone scoops
Cucchiai per osso
Cucharillas para huesos
Curettes à os

Knochenstopfer
Bone tampers - Bone packers
Compattatore per osso
Compactador
Compacteur - Pilons

Knochenmaterialstopfer
Bone pluggers
Compattatore - Spatola
per osso
Condensadore óseos
Fouloirs à os

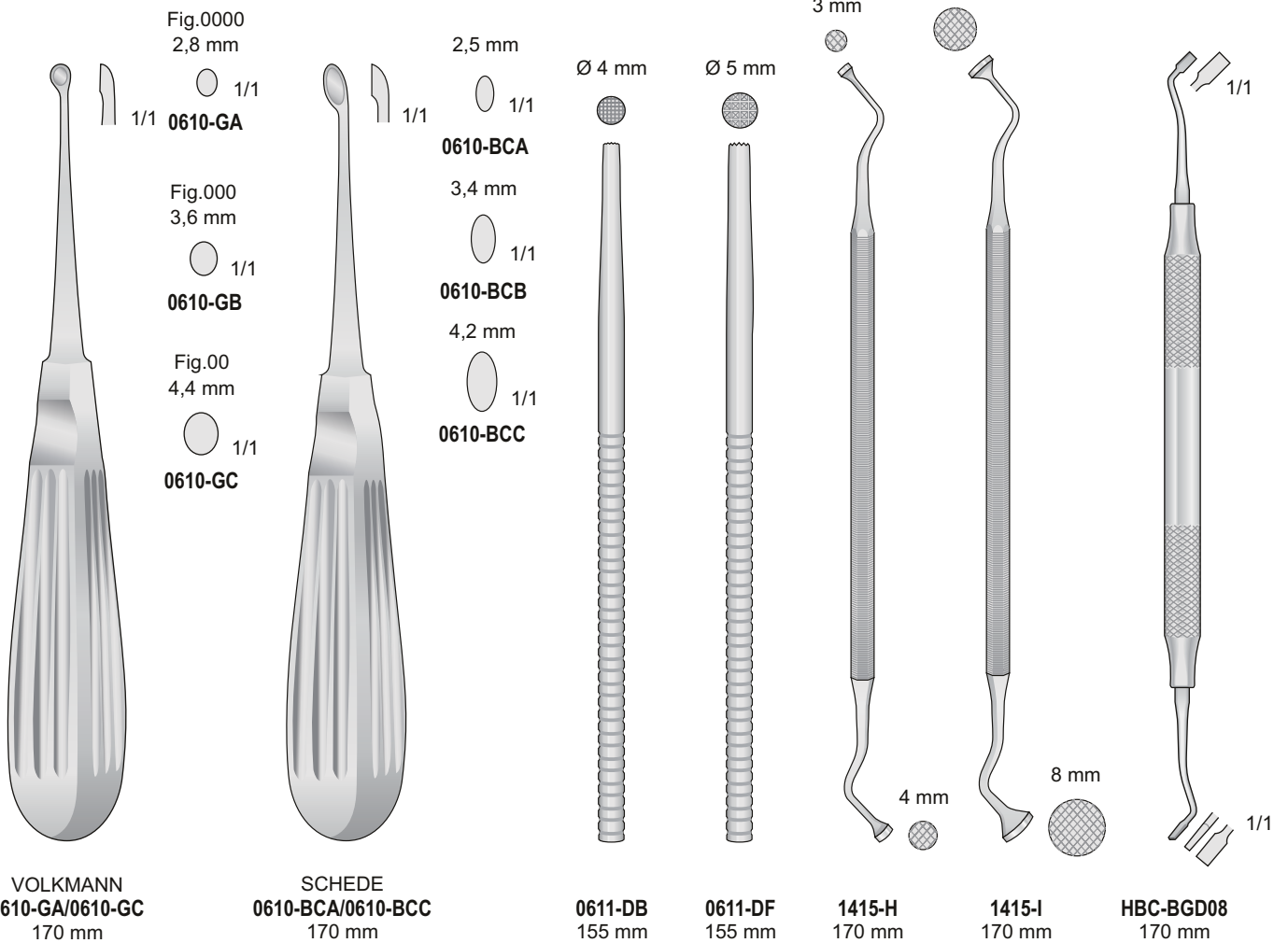

Osteotome

Osteotomes

Osteotomi

Ostéotomes

Osteotomos

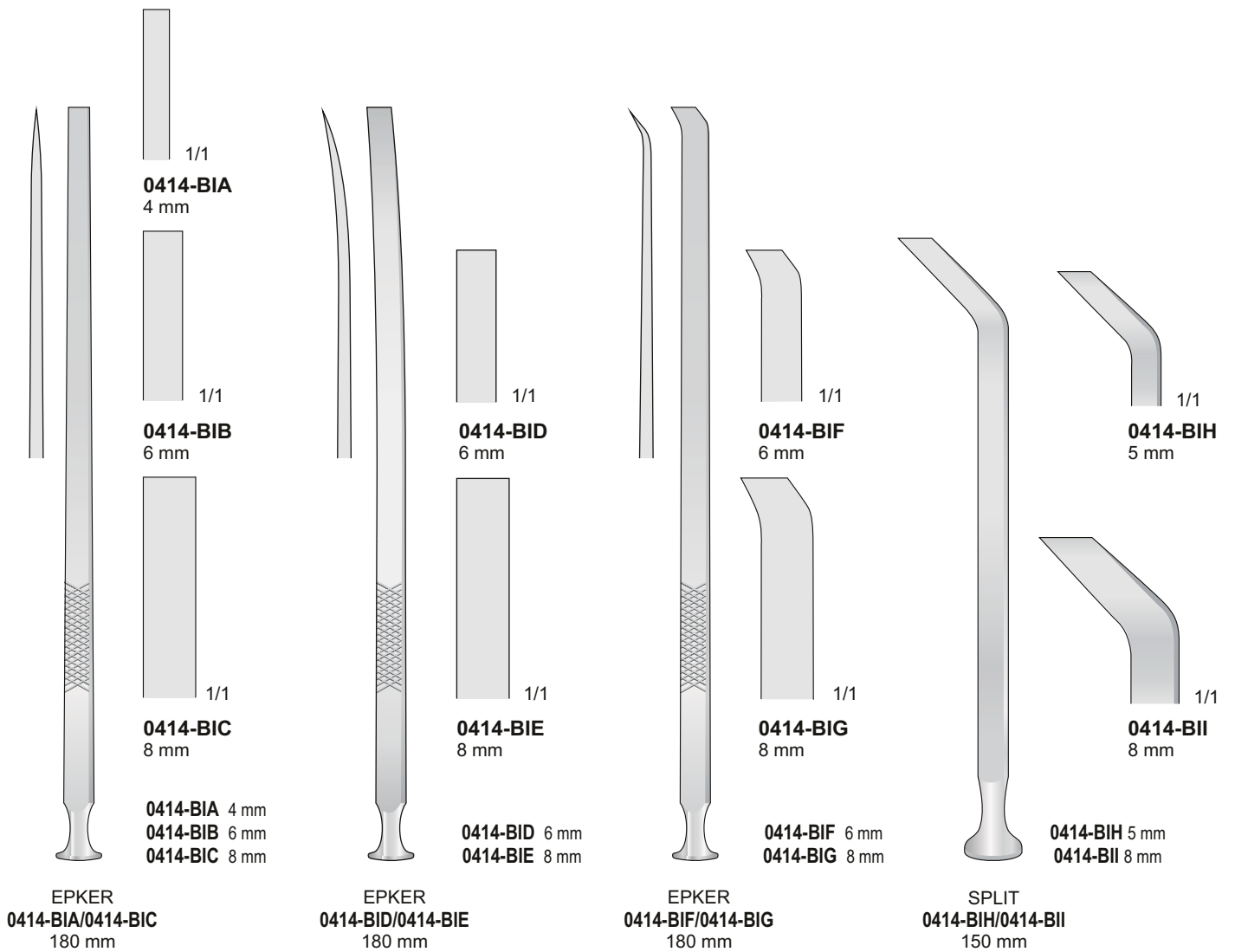

**Meissel
Osteotome**

Fig. 4



**OCHSENBEIN
141802-E01
170 mm**

**Chisels
Osteotomes**

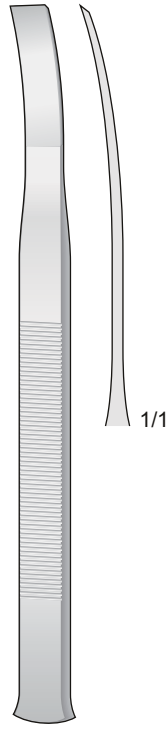

**TESSIER
0611-EAE 10 mm
160 mm**

**Scalpelli
Osteotomi**

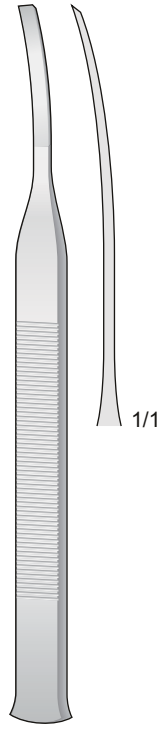

**TESSIER
0611-EBB 5 mm
0611-EBC 7 mm
160 mm**

**Cinceles
Osteótomos**



**TESSIER
0611-EBD/0611-EBG
160 mm**

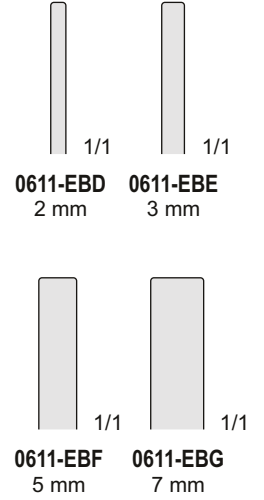

2 mm

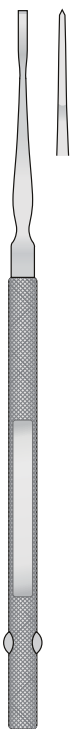

**FREER
1907-CA
160 mm**

4 mm

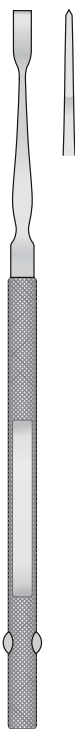

**FREER
1907-CB
160 mm**

6 mm



**FREER
1907-CC
160 mm**

4 mm

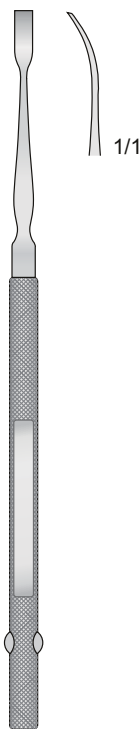

**FREER
1907-CD
160 mm**

3 mm

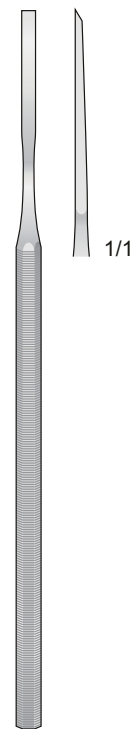

**1907-DA
155 mm**

6 mm

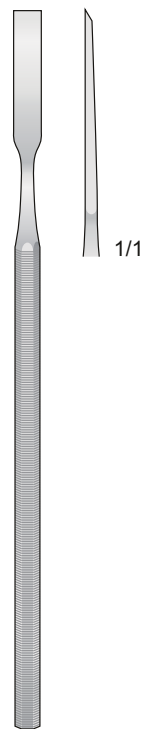

**1907-DB
155 mm**

9 mm

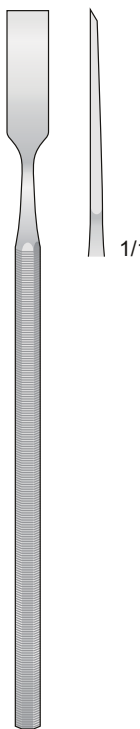

**1907-DC
155 mm**

9 mm

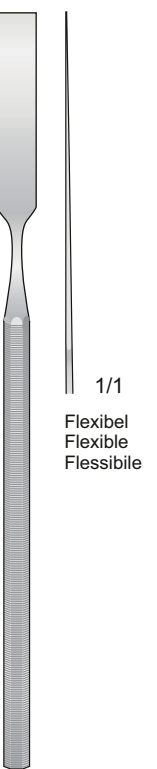

**1907-BF
170 mm**

1/1
Flexibel
Flexible
Flessibile

Hämmer

Mallets

Martelli

Martillos

Maillets

Mit auswechselbaren Kunststoffbacken
 With interchangeable plastic disks
 Con punte e ricambi in teflon
 Con tapas de plástico reemplazables
 Avec embouts de plastique rechargeables

Ø 20 mm
160 g

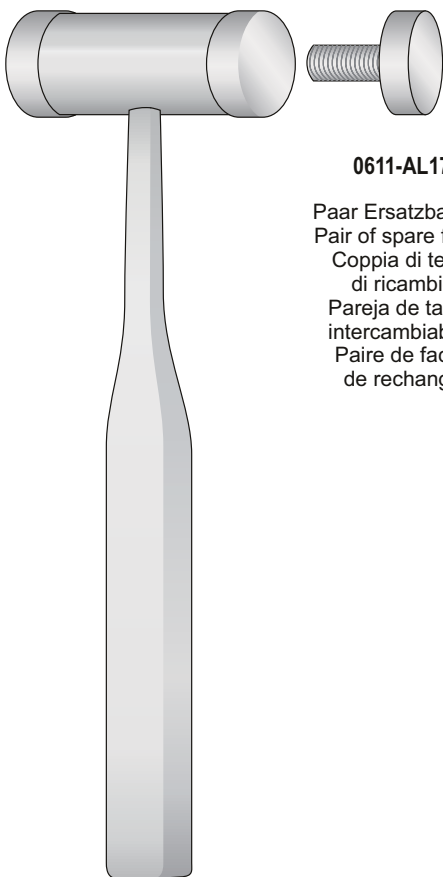

0611-AL17

Paar Ersatzbacken
 Pair of spare faces
 Coppia di teste
 di ricambio
 Pareja de tapas
 intercambiables
 Paire de faces
 de rechange

0611-AL
190 mm

Ø 25 mm
200 g

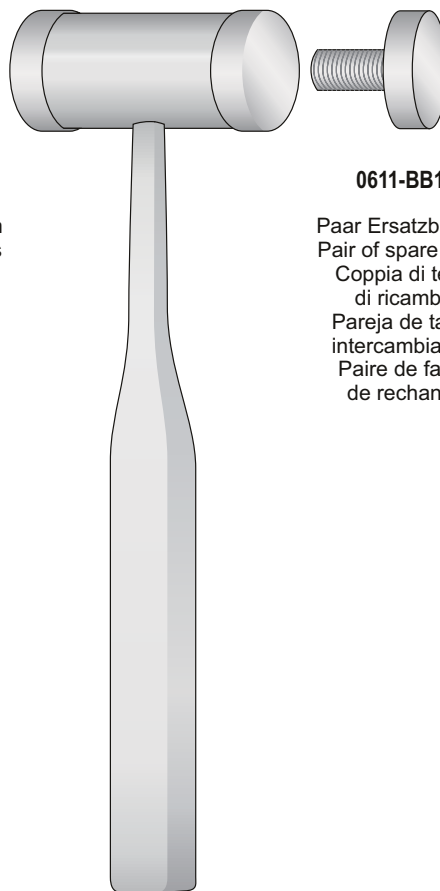

0611-BB17

Paar Ersatzbacken
 Pair of spare faces
 Coppia di teste
 di ricambio
 Pareja de tapas
 intercambiables
 Paire de faces
 de rechange

0611-BB
200 mm

Ø 26 mm
320 g

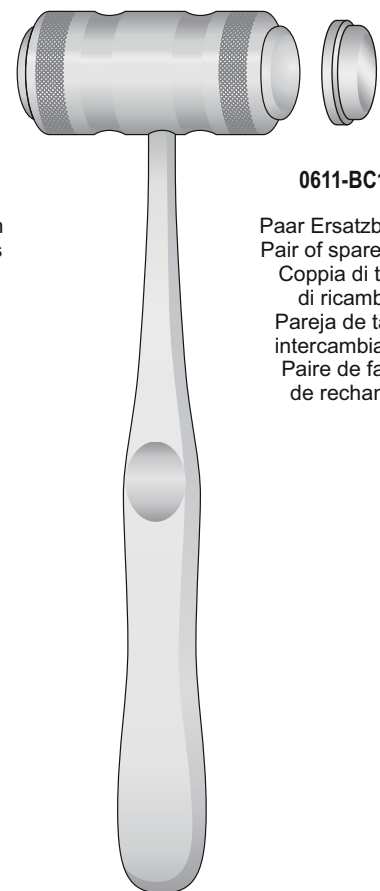

0611-BC17

Paar Ersatzbacken
 Pair of spare faces
 Coppia di teste
 di ricambio
 Pareja de tapas
 intercambiables
 Paire de faces
 de rechange

MEAD
0611-BC
190 mm

Knochenmeißel Graduiert
 Graduated Chisels
 Scalpelli graduati
 Osteótomos graduado
 Ostéotomes gradués

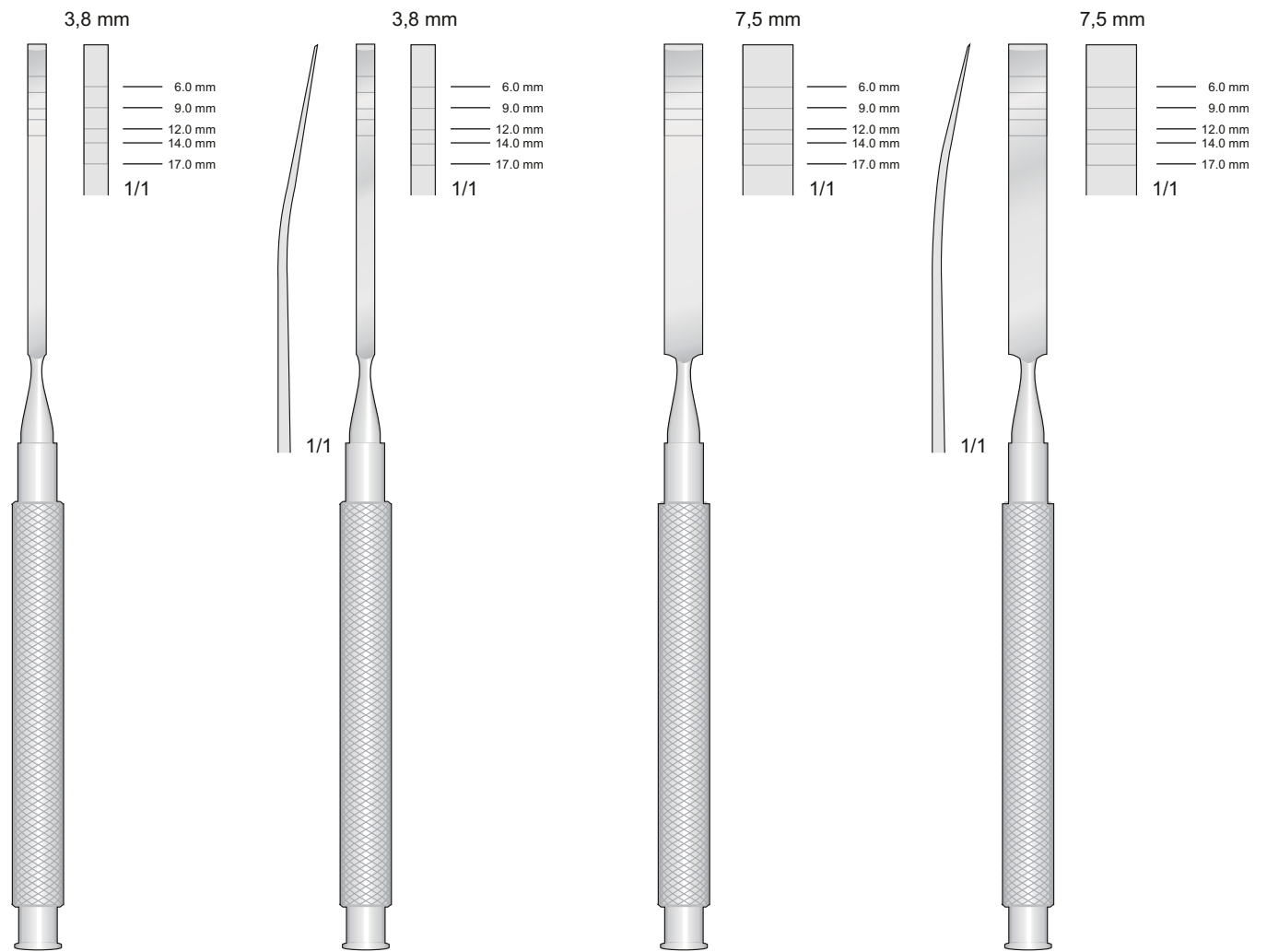

0611-BEB
170 mm

0611-BEC
170 mm

0611-BED
170 mm

0611-BEE
170 mm

Implant Sinus Lift Osteotomes

0611-EAA
 Komplettsset mit
 Set complete with
 Set completo con
 Kit completo con
 Set complete avec

0218-GA
0611-DLB/0611-DLL
 (Fig.1 - 2 - 3 - 4 - 5 - 6 - 7 - 8 - 9)

Fig. 1
 Ø 2.5 mm



0611-DLB
 155 mm

Fig. 2
 Ø 2.5 mm



0611-DLC
 155 mm

Fig. 3
 Ø 2.5 mm



0611-DLD
 155 mm

Fig. 4
 Ø 2.5 mm



0611-DLE
 155 mm

Fig. 5
 Ø 2.5 mm



0611-DLF
 155 mm

Implant Sinus Lift Osteotomes

0611-EAA12
 Komplettsset mit
 Set complete with
 Set completo con
 Kit completo con
 Set complete avec

0218-GA
0611-DIL/0611-DLL
 (Fig.00 - 0 - 1 - 2 - 3 - 4 - 5 - 6 - 7 - 8 - 9)

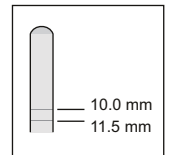
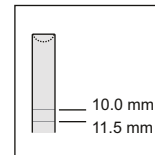

Fig. 6
 Ø 2.5 mm



0611-DLG
 155 mm

Fig. 7
 Ø 2.5 mm



0611-DLH
 155 mm

Fig. 8
 Ø 2.5 mm



0611-DLI
 155 mm

Fig. 9
 Ø 3.1 mm



0611-DLL
 155 mm

Fig. 00
 Ø 3.0 mm

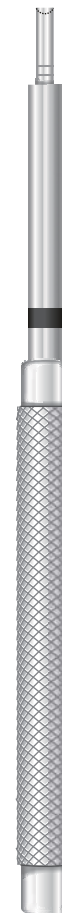

0611-DIL
 155 mm

Fig. 0
 Ø 3.0 mm



0611-DLA
 155 mm

Fig. 1		Fig. 2		Fig. 3		Fig. 4		Fig. 5		Fig. 6	
Height	Diameter	Height	Diameter	Height	Diameter	Height	Diameter	Height	Diameter	Height	Diameter
0	Ø 1,60	0	Ø 1,90	0	Ø 2,80	0	Ø 3,10	0	Ø 3,90	0	Ø 5,50
7,5	Ø 1,80	7,5	Ø 2,20	7,5	Ø 3,20	7,5	Ø 3,70	10	Ø 5	10	Ø 6,20
10	Ø 2	10	Ø 2,35	10,5	Ø 3,35	10,5	Ø 3,90	13	Ø 5,20	13	Ø 6,30
13,5	Ø 2,40	13,5	Ø 3,30	13,5	Ø 3,60	15,5	Ø 4,30	20,5	Ø 6,30		
15,5	Ø 3,60	15,5	Ø 3,40	21	Ø 4,40						
		23,5	Ø 4,50								

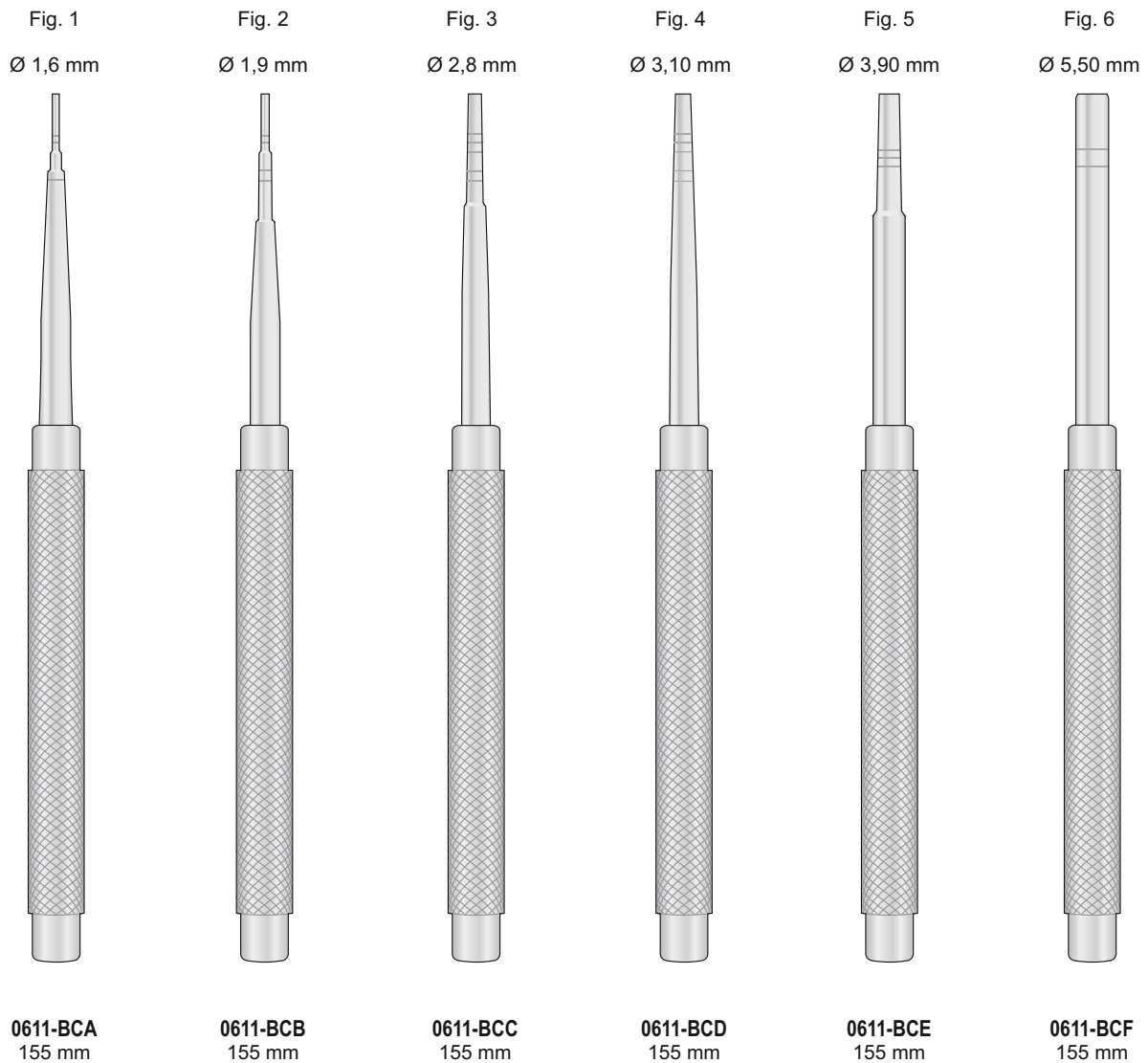

L.	Ø 1° osteotome	Ø 2° osteotome	Ø 3° osteotome	Ø 4° osteotome	Ø 5° osteotome
0	1,5	2,1	2,6	3,0	3,5
5	1,9	2,6	3,0	3,5	3,9
8	2,2	2,8	3,3	3,8	4,2
10	2,4	3,0	3,5	4,0	4,4
12	2,6	3,2	3,7	4,2	4,6
14	2,8	3,4	3,9	4,4	4,8

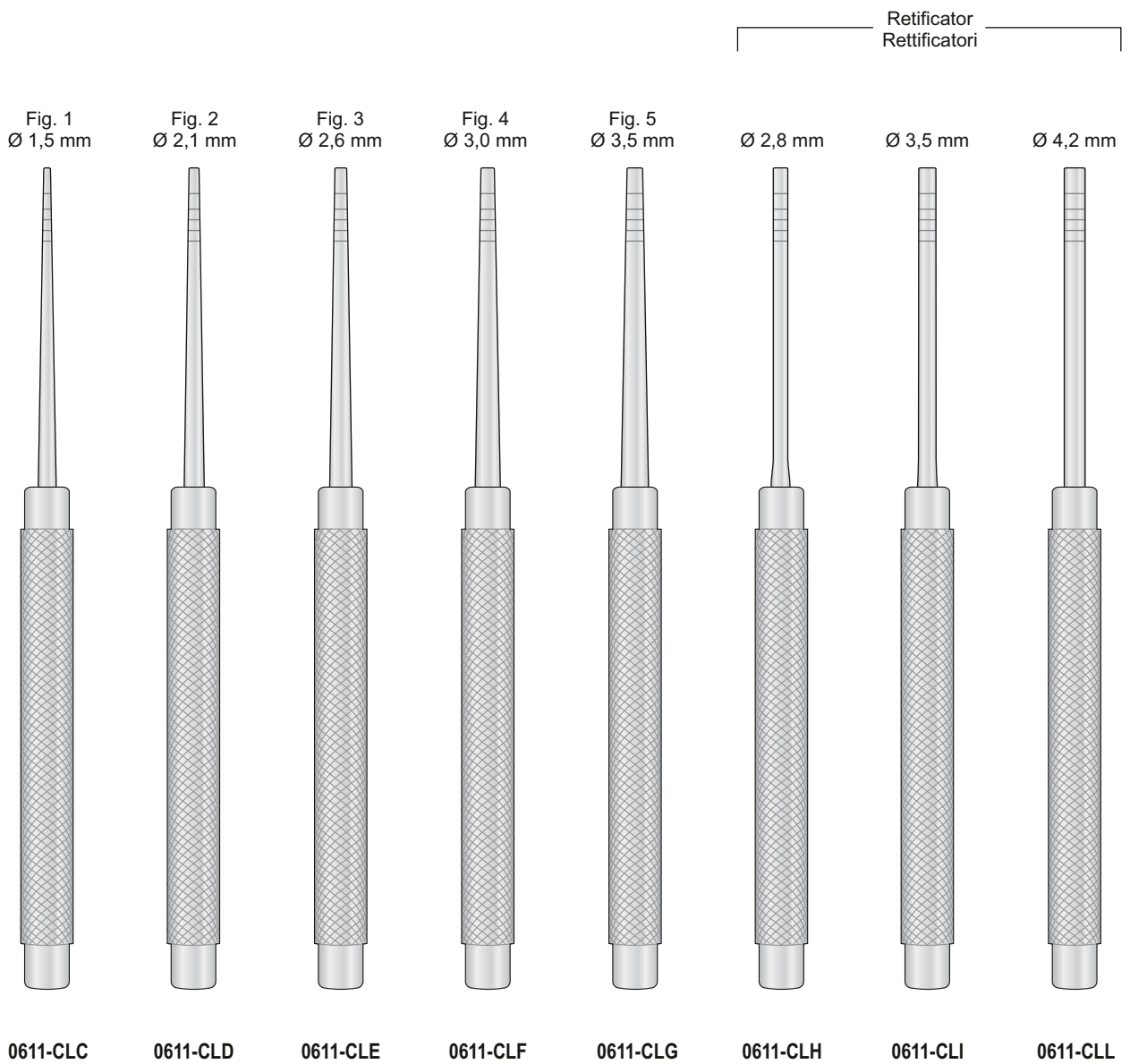

Osteotome konkav mit Stop - Osteotomes concave with Stop
 Osteotomi concavi con Stop - Osteótomos cóncavo con Stop
 Ostéotomes concaves avec Stop

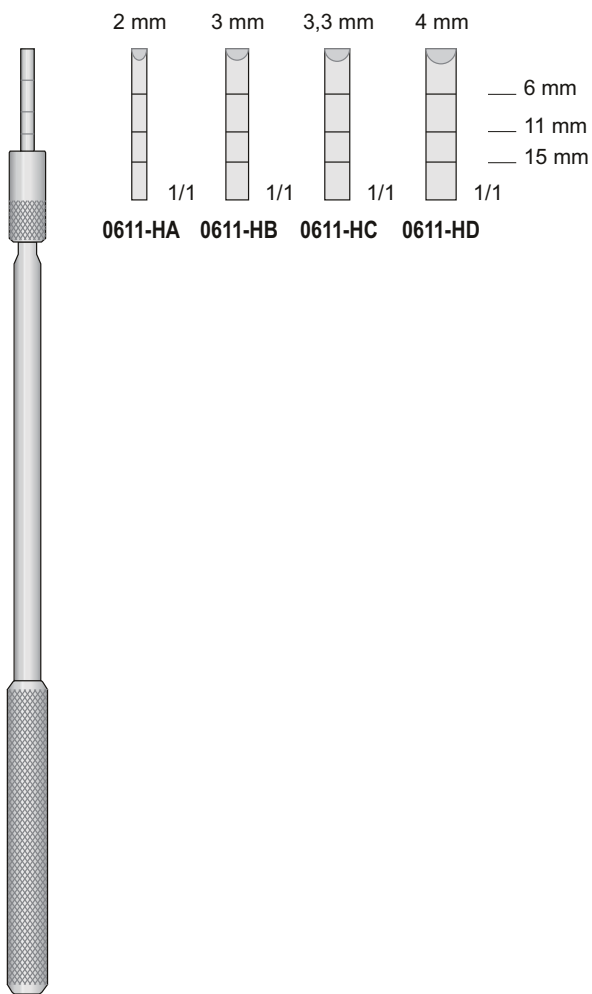

0611-HA/0611-HD
165 mm

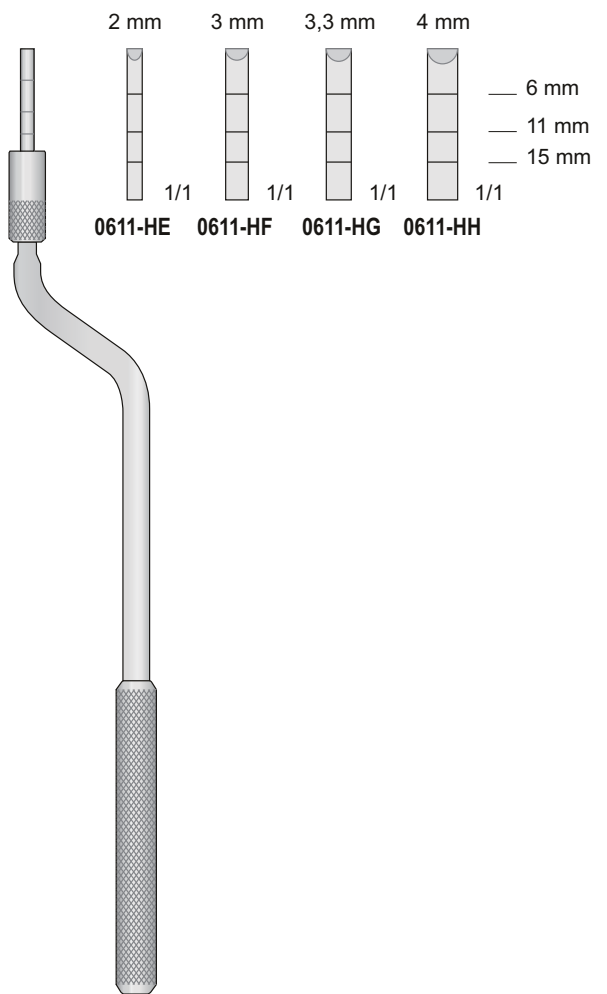

0611-HE/0611-HH
165 mm

Osteotome konvex mit Stop - Osteotomes convex with Stop
 Osteotomi convessi con Stop - Ostéotomos convexe con Stop
 Ostéotomes convexes avec Stop

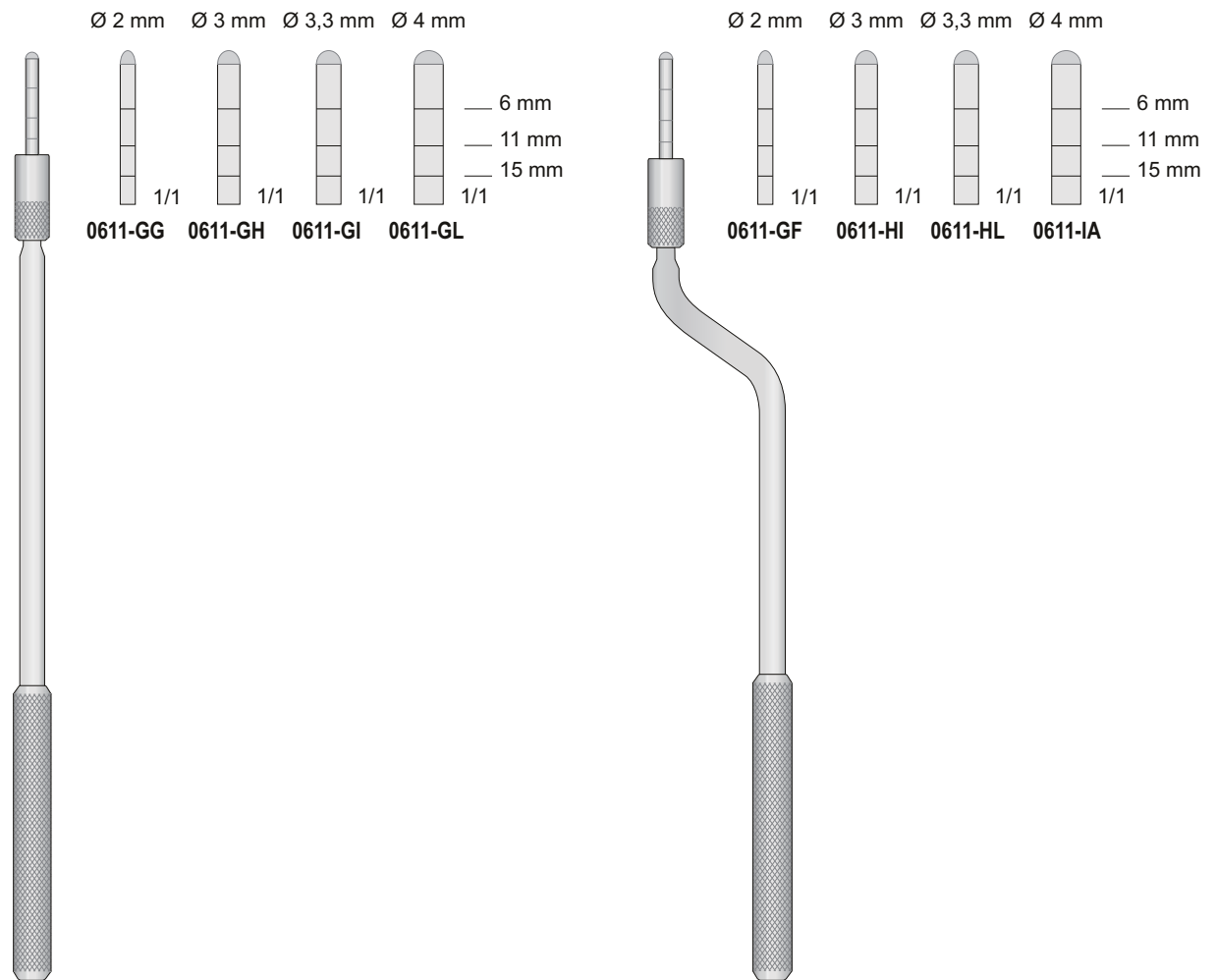

0611-GG/0611-GL
165 mm

0611-GF/0611-IA
160 mm

Osteotome

Osteotomes

Osteotomi

Osteótomos

Ostèotomes

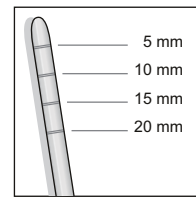
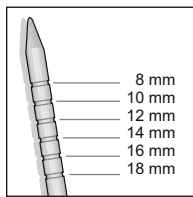

Implant Site Dilator
Implant Site Dilators
Dilatatori per osso
Dilatadores oséos
Dilatateur d'os

Expansion Osteotome
Expansion Osteotomes
Espansori di osso
Expansores oséos
Expanseurs d'os

Ø 2 mm

Ø 3 mm

Ø 3,3 mm

Ø 4 mm

Ø 3 mm

Ø 4 mm

Ø 5 mm



0611-CF
145 mm

0611-CG
145 mm

0611-CH
145 mm

0611-CI
145 mm

0611-DH
145 mm

0611-DI
145 mm

0611-DL
145 mm

Trephine

Trephine Burs

Frese carotatrici - Trephine

Trephine

Trephine

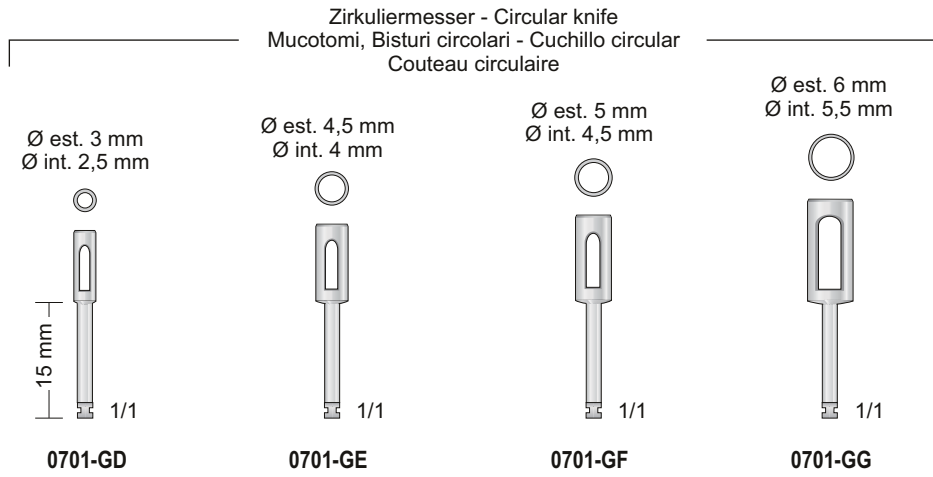
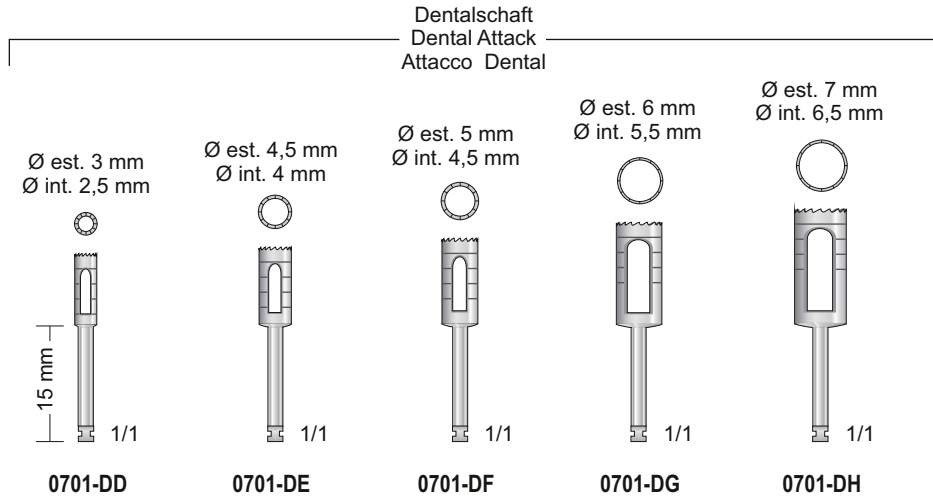

Hautstanzen - Tissue punches
Mucotomi Punches - PUNCHES para cortar tejidos
Punches à couper le tissu

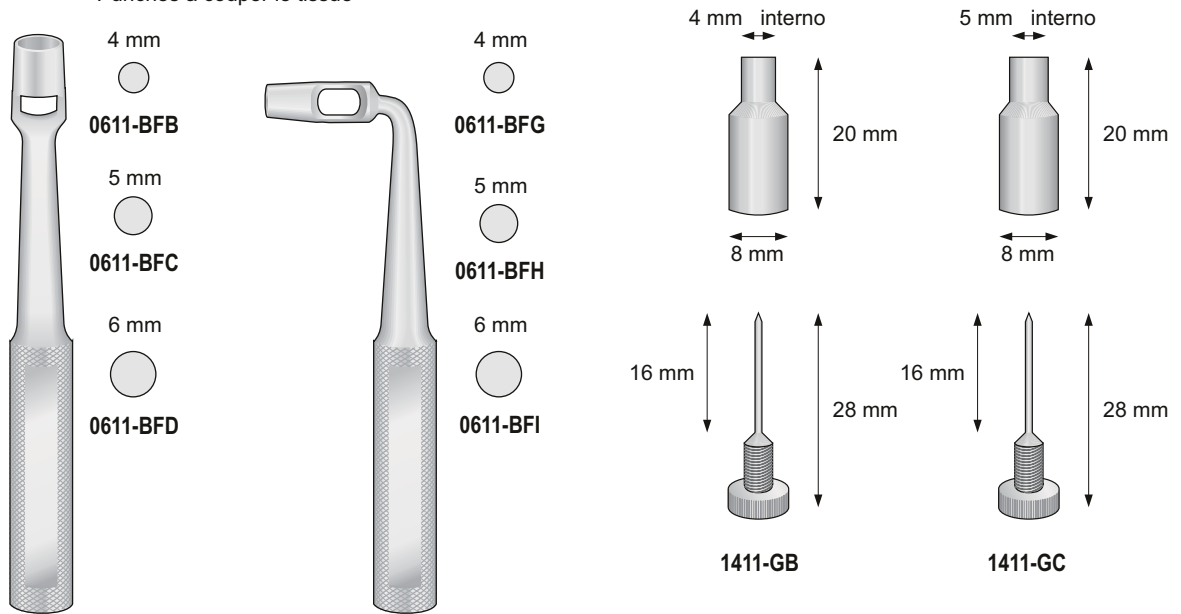

KEYES
0611-BFB/0611-BFD
100 mm

KEYES
0611-BFG/0611-BFI
90 mm

Implantologie
Instrumente

Implantology
Instruments

Strumenti per
implantologia

Implantologia
Instrumentos

Implantologie
Instruments

Knochenschale
Bone Well
Bacinella per osso
Cubeta para hueso
Cuvette à os



Rostfrei
Stainless Steel
Acciaio inossidabile
Acero inoxidable
Acier Inoxydable

1818-GF
35 mm

Absaugkanülen für Knochen, mit 1 Filter
Suction tube for bone, with 1 filter
Cannule d'aspiration con trattenuta osso, con 1 filtro
Cánulas aspiradoras para hueso, con 1 filtro
Canule à aspiration d'os avec 1 filtre

Knochenfilter
Bone Filter
Filtro per osso
Filtro de hueso
Filtre d'os

Rostfrei
Stainless Steel
Acciaio inossidabile
Acero inoxidable
Acier Inoxydable

Ø 10 mm int.

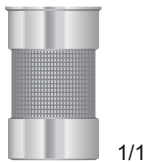

0706-BDE
20 mm

Sterilisierbar
Autoclavable
Autoclavabile

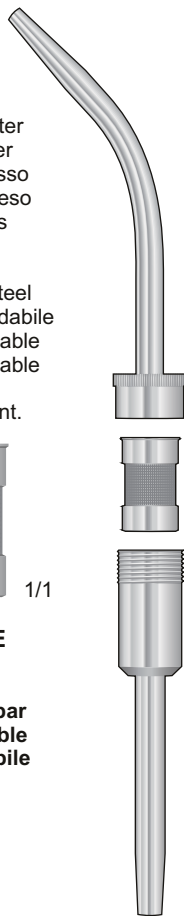

0706-BDD
180 mm

Membranplatzierungsinstrumente
Membrane Placement Instruments
Strumenti per posizionare membrana
Instrumentos para colocar membranas
Instruments d'application de membrane

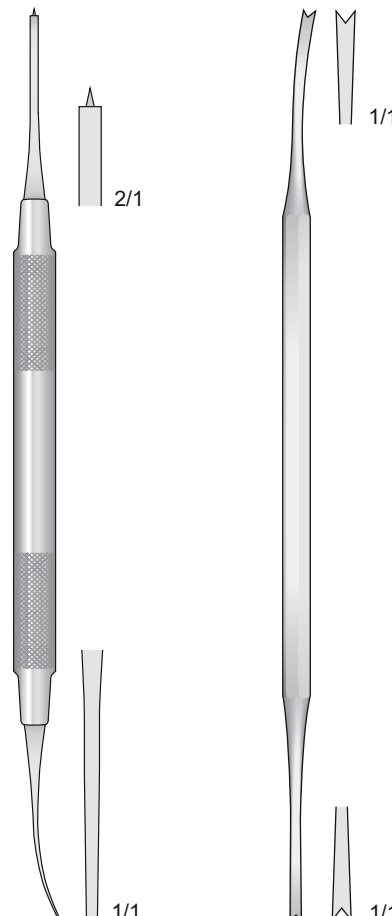

121509-B
185 mm

LUNIATSCHEK
1506-G
170 mm

Aufbring Instrument
für Knochenmaterial
Applicator for bone material
Applcatore per materiale osseo
Cucharillas para huesos
Curettes à os

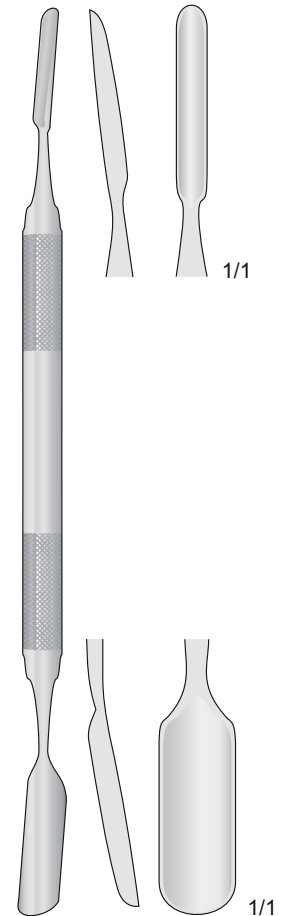

0912-BF
180 mm

Knochenschaber
Rostfrei Stahl

Bone scraper
Stainless Steel

Grattini per osso
Inox

Raspador de hueso
Acero inoxidable

Râpes à os
Acier inoxydable

Multiple use, Replaceable blades
Ideale per il prelievo di osso autologo

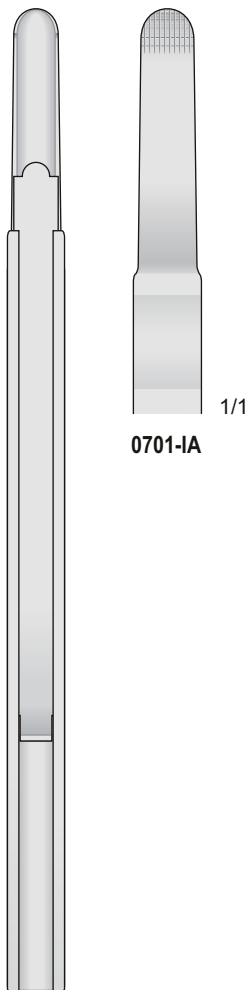

0701-IA

0701-IA
155 mm

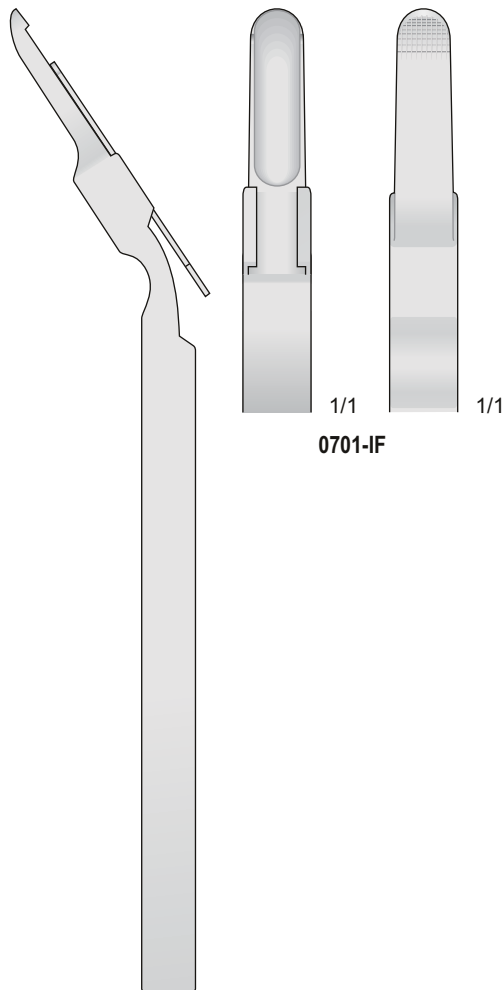

0701-IF

0701-IF
155 mm

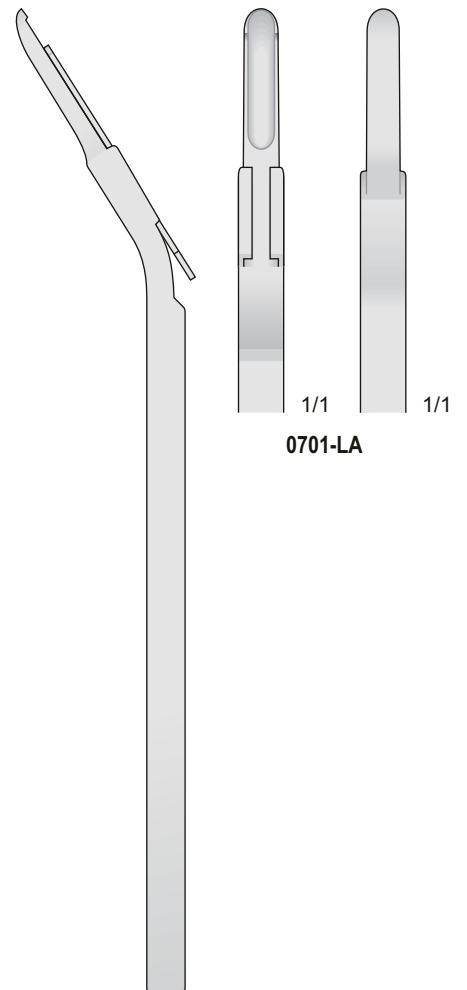

0701-LA

0701-LA
155 mm

0701-LF

Abnehmbarer Griff
Handle
Manico ad innesto
Mango de innesto
Manche à greffe
195 mm

0701-LG

Knochenbehälter
Container for bones
Vaschetta porta-osso con presa
Caja porta hueso
Réceptade d'os

0701-LH

Oberer Knochendrücker
Presse bone superior
Tassello spingi-osso superiore
Enchufe para los huesos
Poussoir d'os supérieur

0701-LI

Gips Reibe Fein #1
Plaster Rasp Fine #1
Grattugia per CIPS fine #1
Cilindro de corte fino #1
Ràpe pour chips fin #1

0701-LL

Gips Reibe Groß #2
Plaster Rasp Large #2
Grattugia per CIPS grossi #2
Cilindro de corte grande #2
Ràpe pour chips large #2

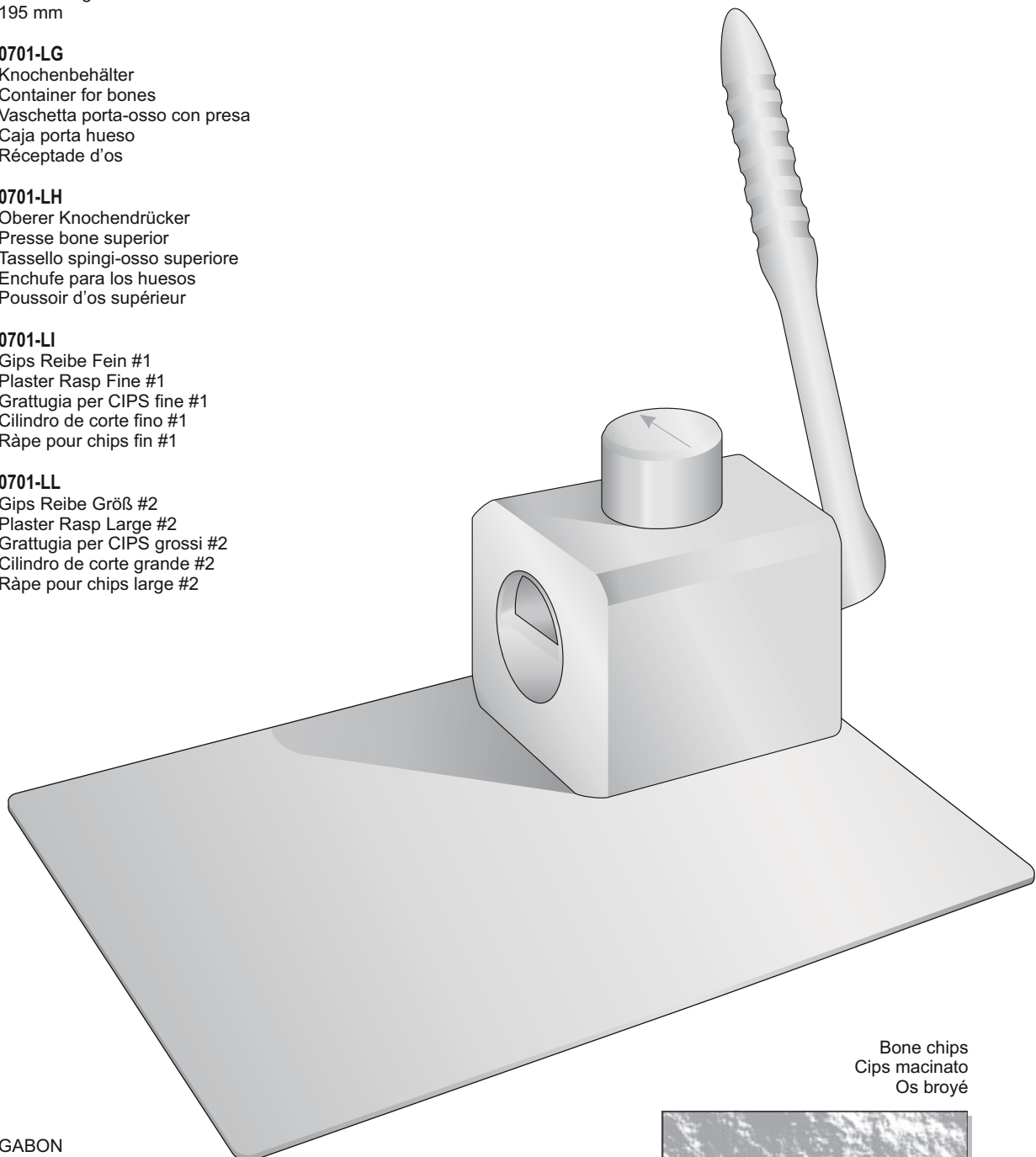

Bone chips
Cips macinato
Os broyé



GABON
0701-BAA

235 x 160 x 100 mm
Kg 4,5

Nur mit 1 Gips Reibe
Only with 1 Plaster Rasp
Comprende una sola grattugia
Con 1 cilindro de corte
Avec 1 cylindre de coupe

Einbringinstrument f3r Knochenmaterial
Graft materials Syringes
Inserters for Bone material
Siringhe per biomateriali

Knochenspritzen
Bone Syringes
Siringhe per osso
Jeringas de hueso
Seringues 3 os

Ø Int. 2,5 mm
Ø Est. 3,5 mm

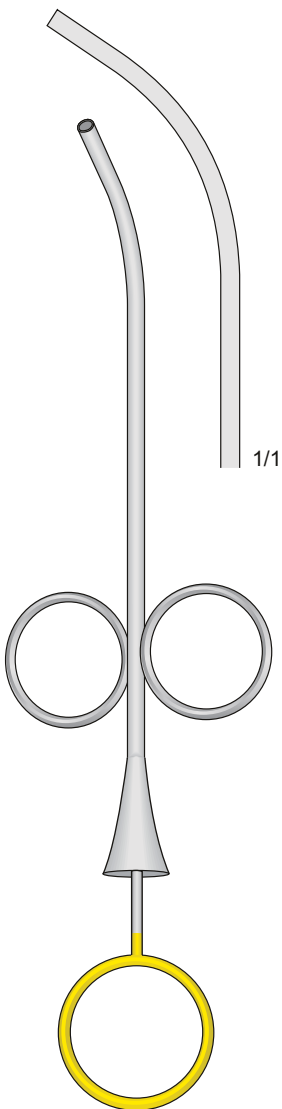

1818-GA12
160 mm

Ø Int. 3,5 mm
Ø Est. 4,5 mm

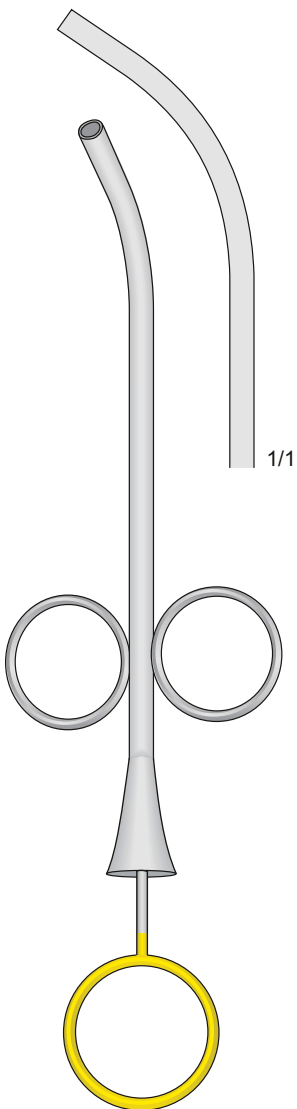

1818-GB12
160 mm

Ø Int. 4,4 mm
Ø Est. 5,5 mm

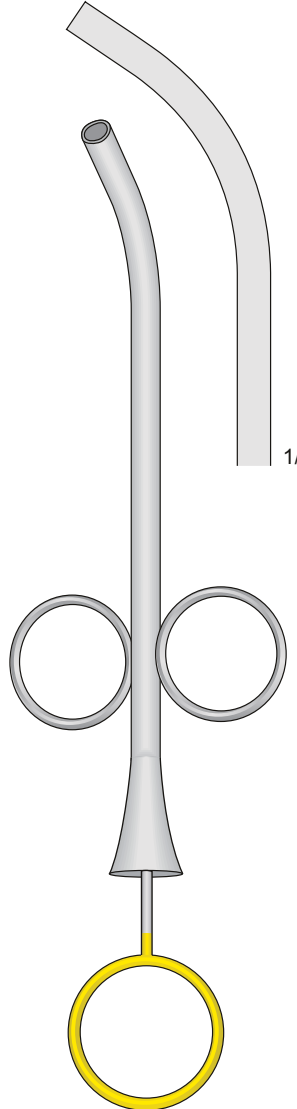

1818-GC12
160 mm

Ø Int. 6 mm
Ø Est. 7 mm

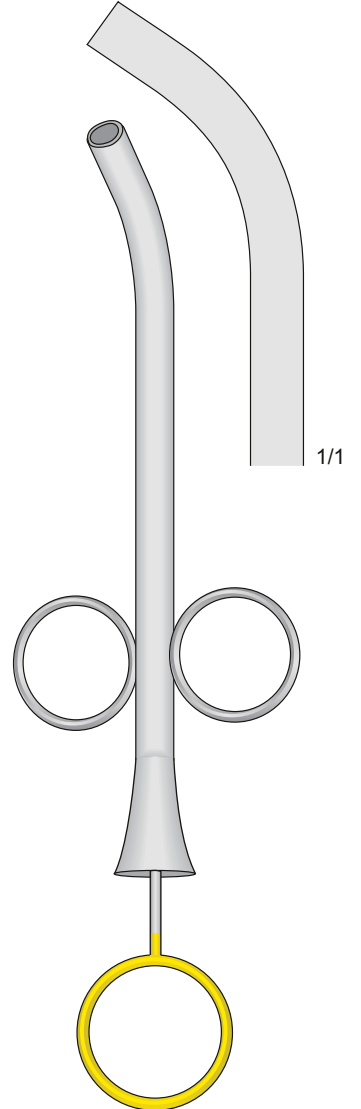

1818-GE12
160 mm

Osteometer

Osteometer

Osteometro

Osteometro

Osteometer

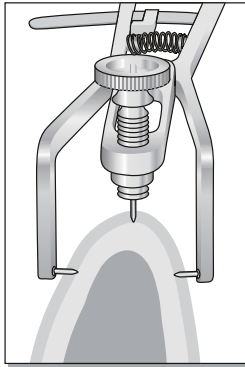

Con punte in titanio

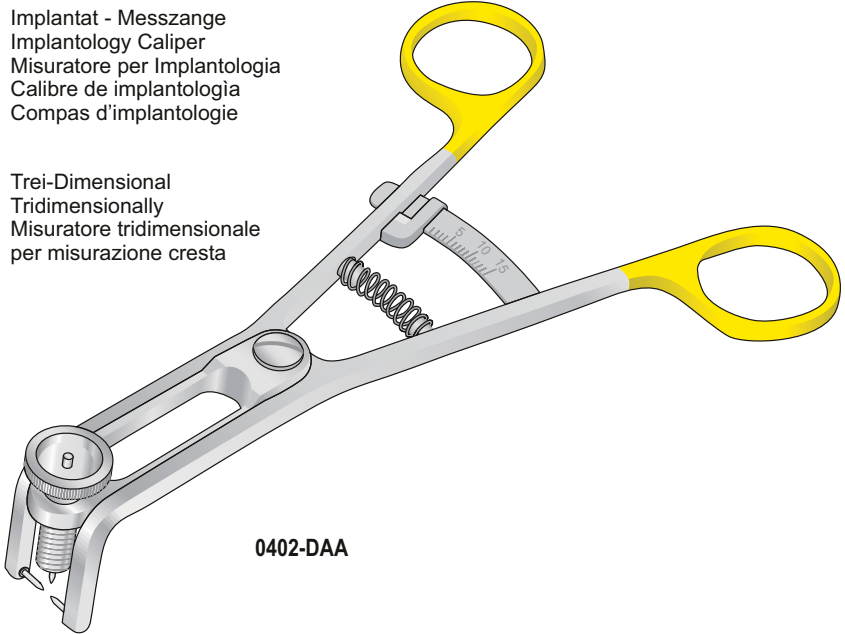

0402-DAA

Implantat - Messzange
 Implantology Caliper
 Misuratore per Implantologia
 Calibre de implantologia
 Compas d'implantologie

Trei-Dimensional
 Tridimensionally
 Misuratore tridimensionale
 per misurazione cresta

Bohrzangen für Knochen-Transplantate
 Bone graft holding and drilling forceps
 Pinza di fissaggio Graft
 Pinzas para coger y taladrar óseo

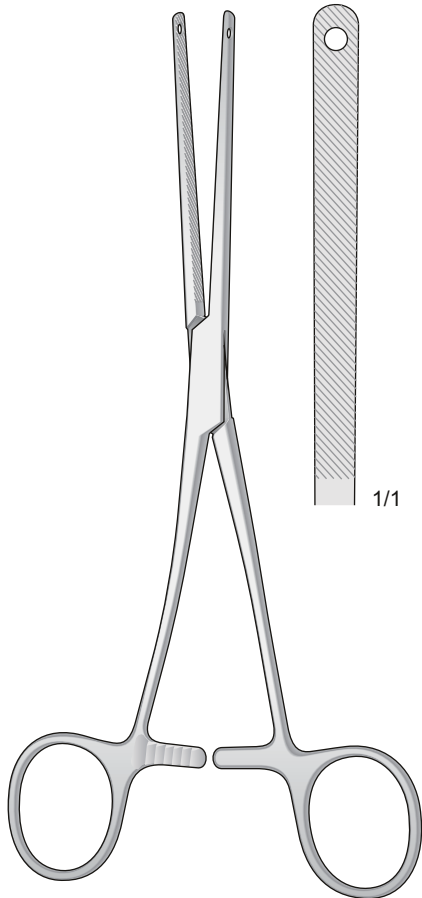

15-DEA
 220 mm

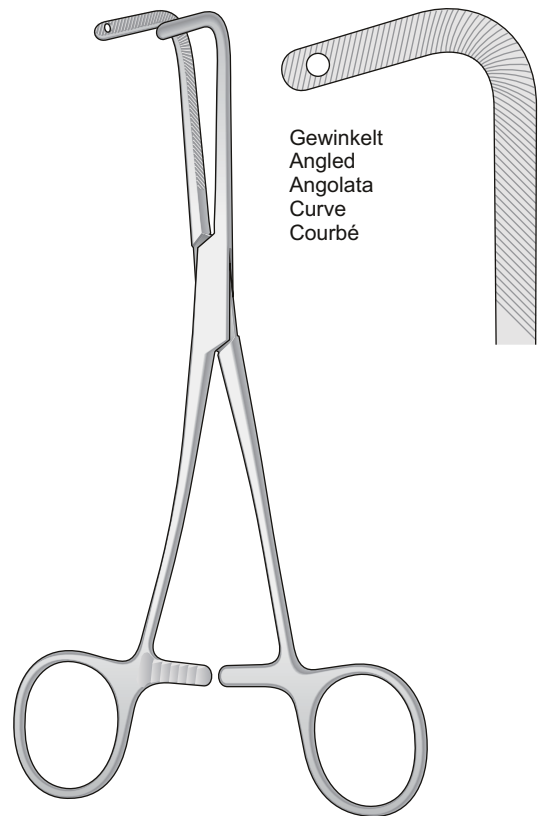

15-DEB
 200 mm

Gewinkelt
 Angled
 Angolata
 Curve
 Courbé

1/1

Hohlmeißelzangen

Bone rongeurs

Pinze ossivore

Pinzas-gubias

Pinces-gouges

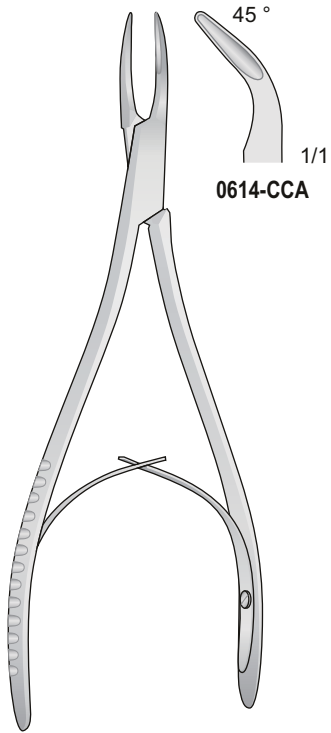

MINI-FRIEDMANN
0614-CCA
150 mm

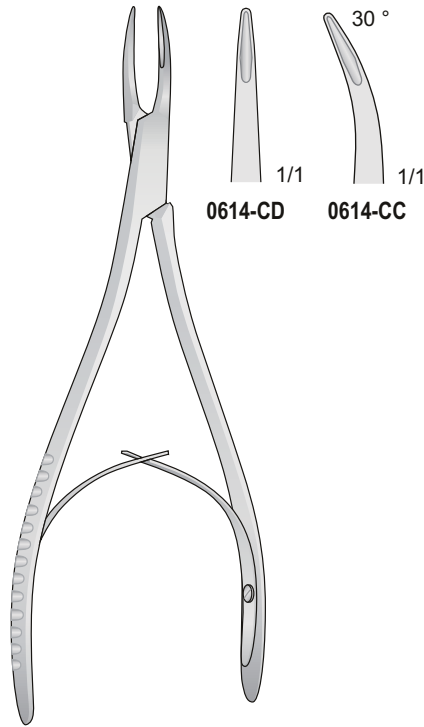

MINI-FRIEDMANN
0614-CC/0614-CD
150 mm

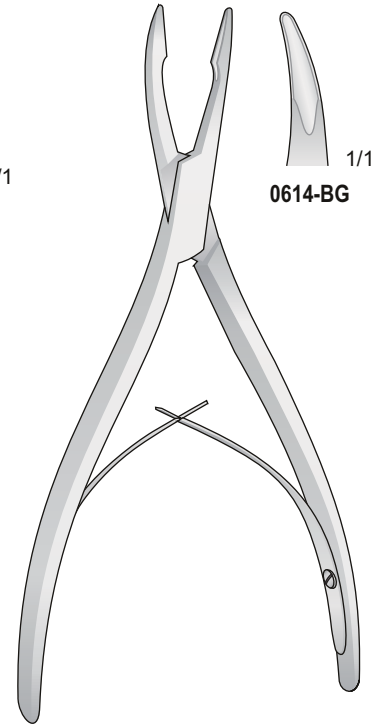

FRIEDMANN
0614-BG
160 mm

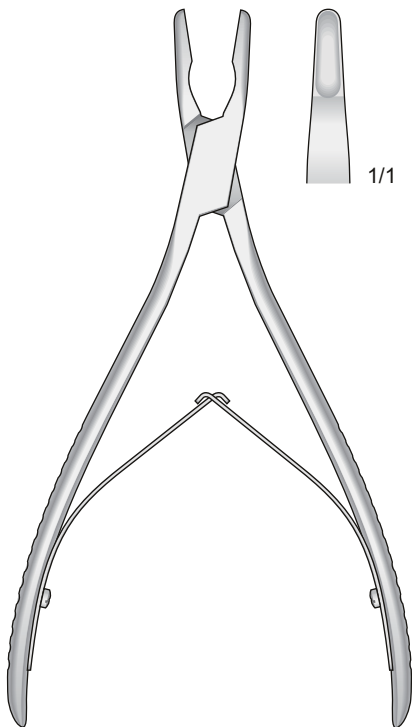

LEMPERT
0614-CCL
155 mm

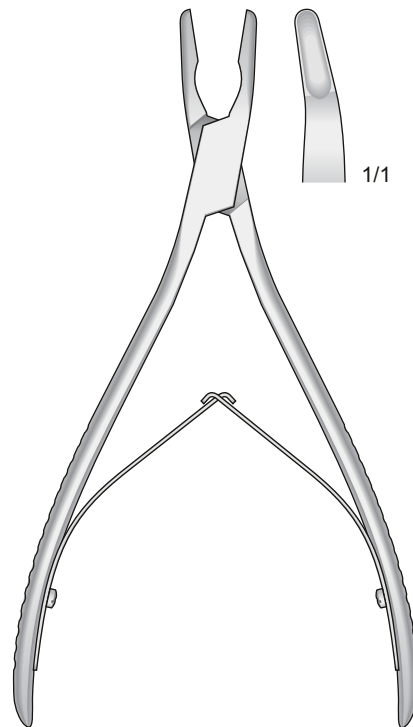

LEMPERT
0614-CDA
155 mm

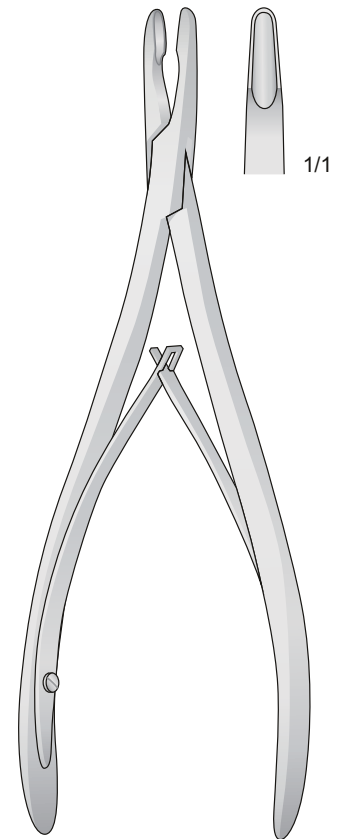

LEMPERT
0614-CF
190 mm

Hohlmeißelzangen

Bone rongeurs

Pinze ossivore

Pinzas-gubias

Pinces-gouges

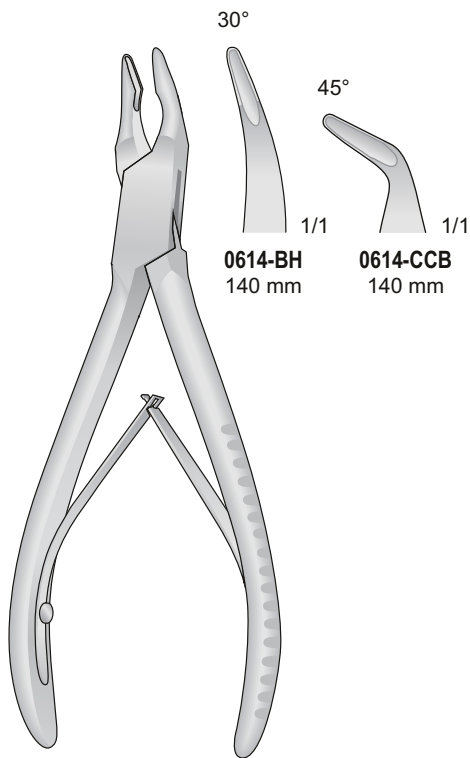

0614-BH
140 mm

0614-CCB
140 mm

FRIEDMANN
0614-BH/0614-CCB
140 mm

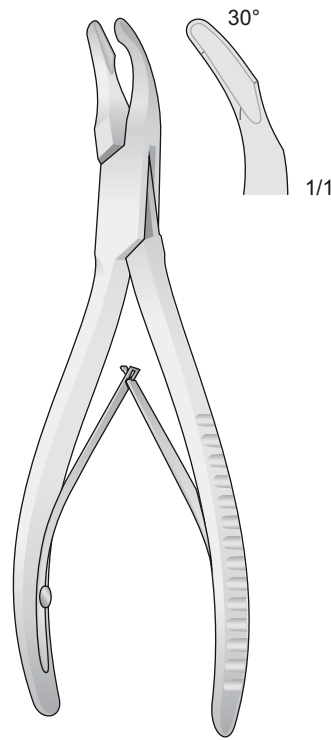

CLEVELAND
0614-CDB
140 mm

Knochensplitterzange
Bone cutting forcep
Pinza tagliente per ossa
Pinzas cortante para huesos
Pinces coupantes à os

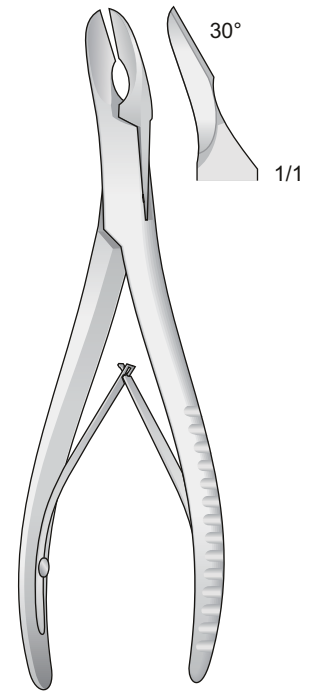

CLEVELAND
0614-CDD
150 mm

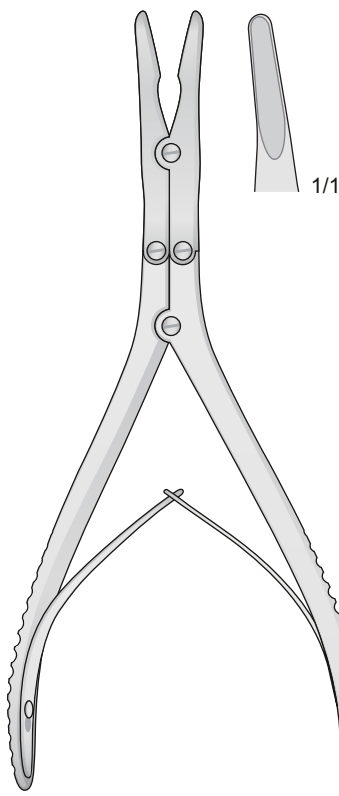

BEYER
0614-CA
180 mm

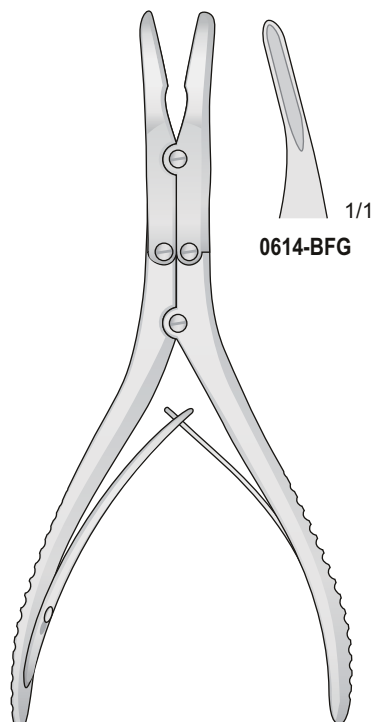

KLEINERT-KUTZ
0614-BFG
155 mm

Knochenhaltezange
Bone holding forceps
Pinza per fissare l'osso
Pinzas para coger huesos
Pinces pour tenir l'os

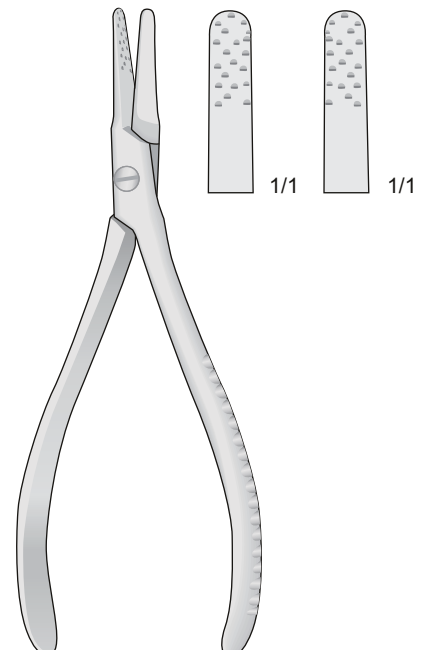

RADOLF
0614-BFL
135 mm

Knochenhaltezange

Bone holding Forceps

Pinze per osso

Pinzas coger huesos

Daviers à os

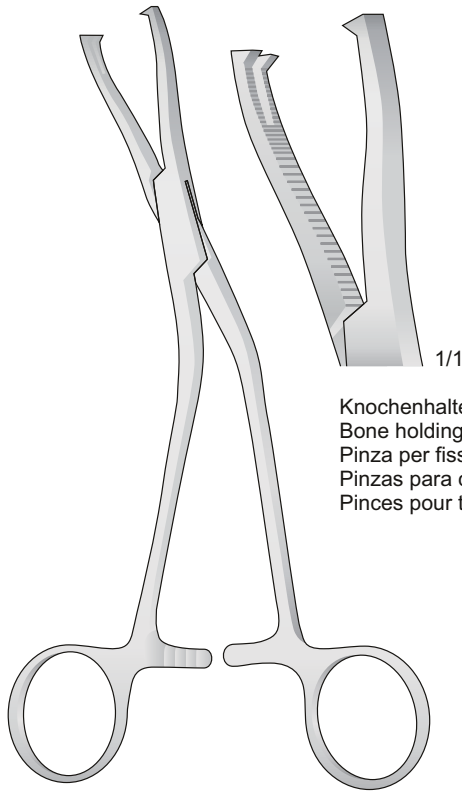

Knochenhaltezange
Bone holding forceps
Pinza per fissare l'osso
Pinzas para coger huesos
Pinces pour tenir l'os

DINGMANN - Mod. Fenestrated Jaw
0614-BDB
190 mm

Knochenquetsche - Bone Crusher
Pinza per modellare l'osso - Aplastador óseo
Broyeur d'os

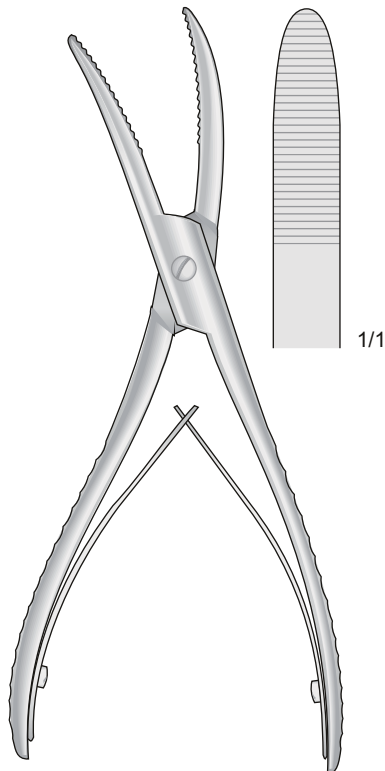

WOLFF
1123-BBD
180 mm

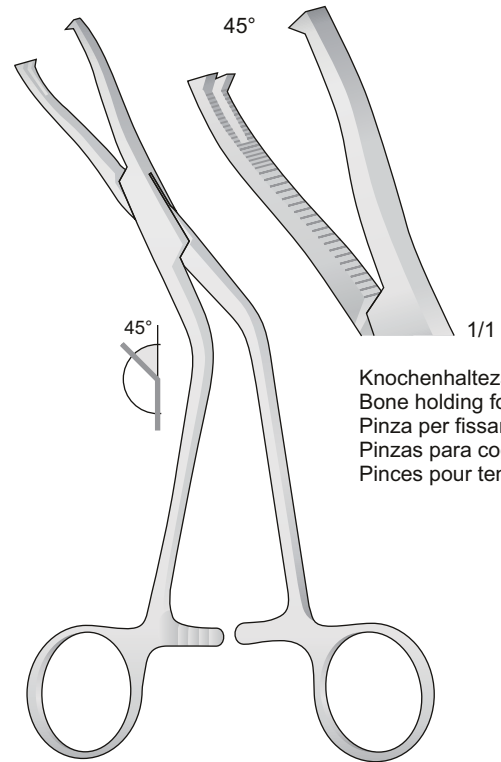

Knochenhaltezange
Bone holding forceps
Pinza per fissare l'osso
Pinzas para coger huesos
Pinces pour tenir l'os

DINGMANN - Mod. Fenestrated Jaw
0614-BDB12
190 mm

Knochenstanze - Bone rongeur
Pinza per osso - Pinza gubia
Pince gouge

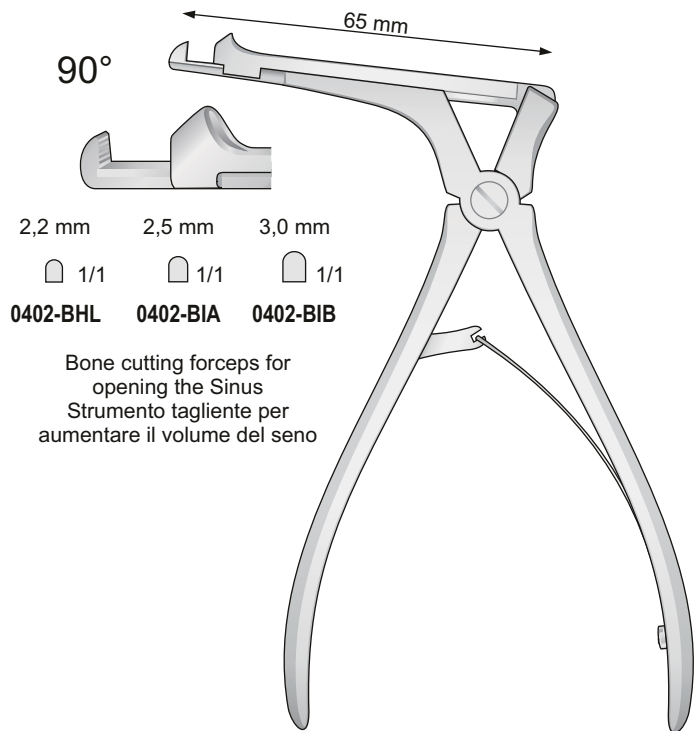

2,2 mm 2,5 mm 3,0 mm
1/1 1/1 1/1
0402-BHL 0402-BIA 0402-BIB

Bone cutting forceps for
opening the Sinus
Strumento tagliente per
aumentare il volume del seno

CITELLI
0402-BHL/0402-BIB

Absaugkanülen

Suctions tubes

Cannule per aspirazione

Cànulas aspiradoras

Canules d'aspiration

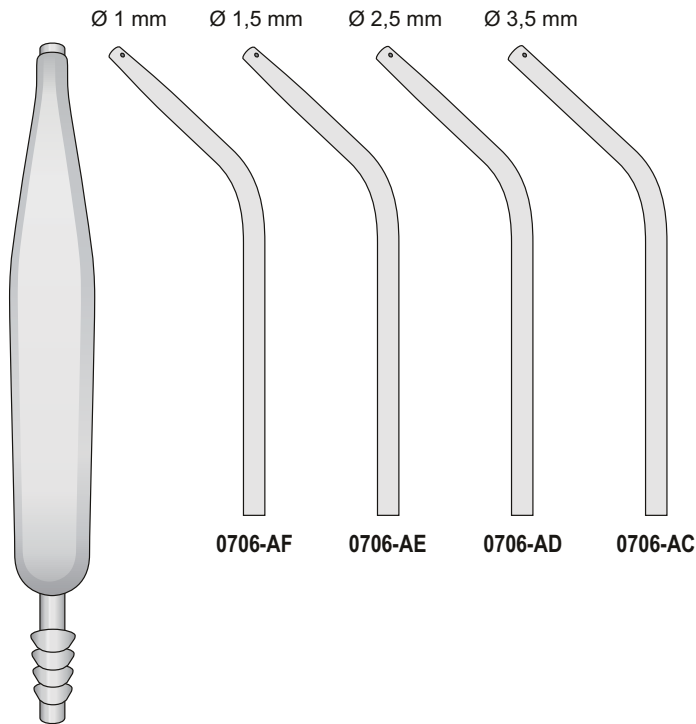

COUPLAND
0706-AB
150 mm

0706-BB
Komplett mit Griffe und 4 Absaugkanülen
Complete with Handles and 4 Suction tubes
Completo di manico con 4 cannule
Completo con Mango y 4 Canulas
Complete avec Manche e 4 Cànulas

0706-AB 0706-AC 0706-AD 0706-AE 0706-AF

Rostfrei - Stainless steel
Acciaio chirurgico - Acero - Acier

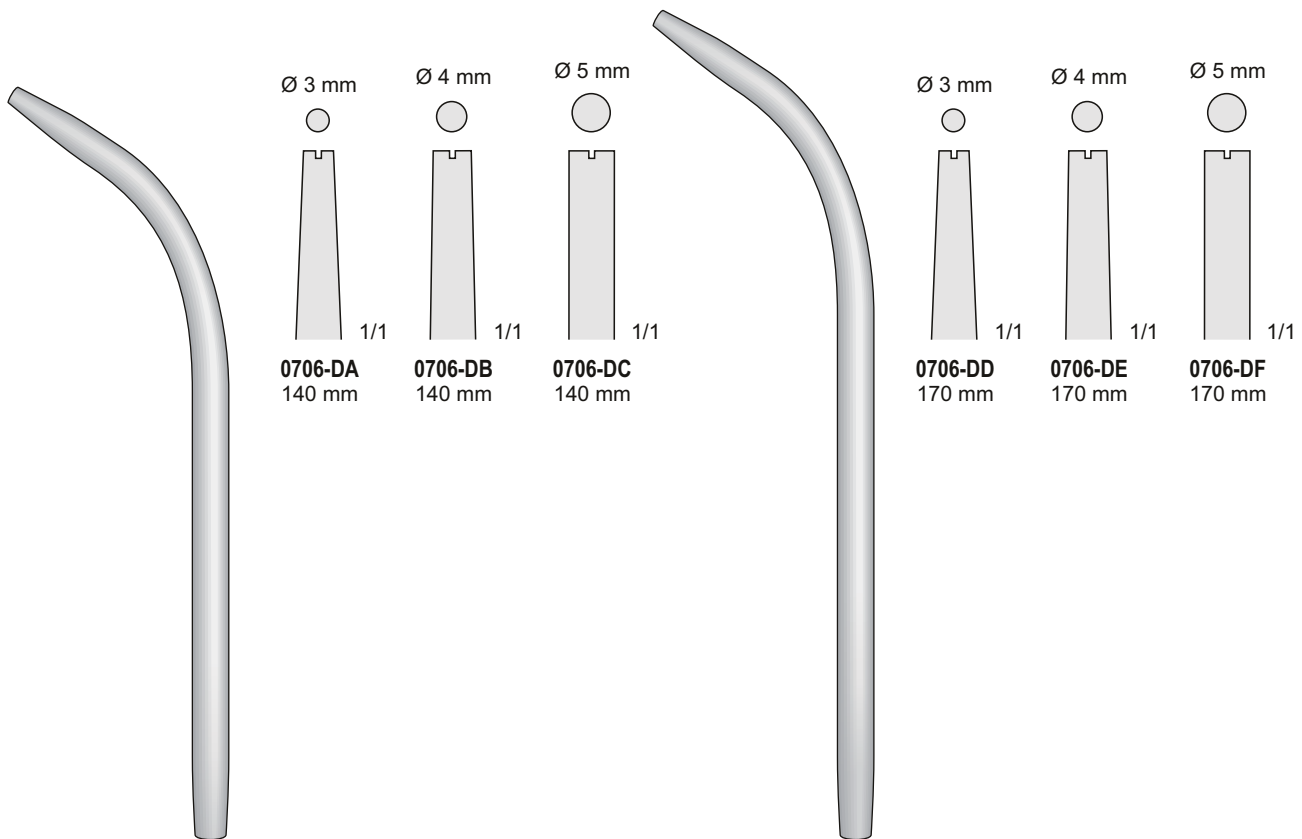

0706-DA/0706-DC

0706-DD/0706-DF

Spülkanüle - Irrigation Needle
 Aghi da lavaggio per ripulitura seno mascellare
 Aguja de instilacion - Aiguilles d'irrigation

Ø 1 mm



1/1

HEPARIN
1411-AH 60 mm
1411-CF 80 mm

Ø 1,5 mm



1/1

HEPARIN
1411-AI 60 mm
1411-CG 80 mm

Metallschalen
 Stainless Steel Bowls
 Capsule inox con fondo piano e becco
 Cubetas de acero inox
 Cuvettes de acier inox

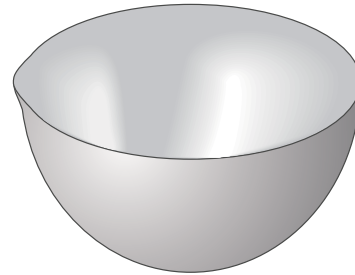

0318-AB Ø 40 mm 15 cc
0318-AC Ø 60 mm 75 cc
0318-AD Ø 80 mm 225 cc
0318-AE Ø 100 mm 325 cc
0318-AF Ø 120 mm 500 cc

Ø Est. 8 mm
 Ø Int. 6 mm
 1/1

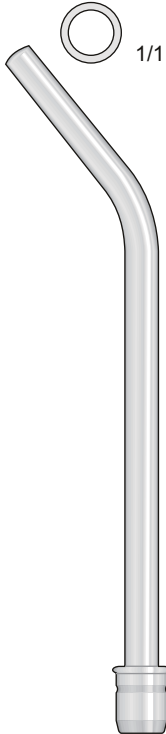

PELTON-CRANE
0706-BIE
 140 mm

Ø Est. 5 mm
 Ø Int. 2,5 mm

1/1

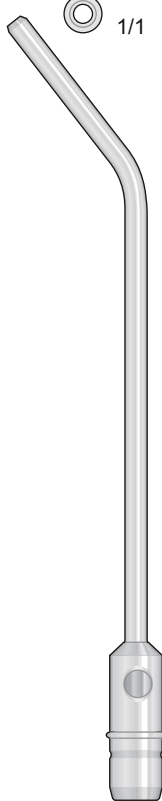

PELTON-CRANE
0706-BIA
 160 mm

1/1

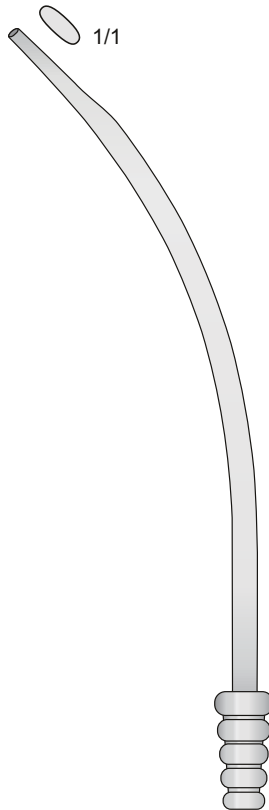

0706-CA
 160 mm

14 mm

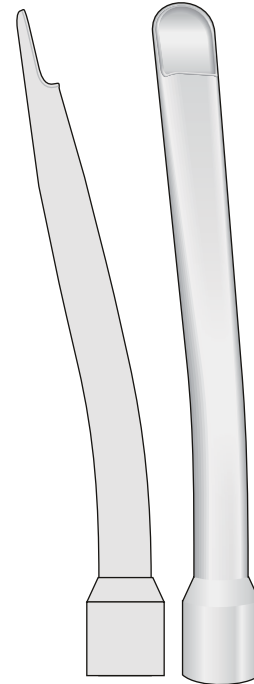

Ø 11 mm
0706-CAG
 130 mm

Ø 4 mm
 Ø 5 mm

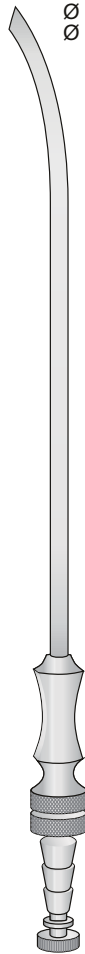

ADSON
0706-EB ch. 12
0706-EC ch. 15
 210 mm

Dental Trays
Container

Dental Trays
Containers

Trays
Contenitori per sterilizzare

Trays
Contenedores para esterilización

Trays
Containers pour stérilizer

Tray Inox mit Silikoneinrichtung - Stainless Steel Cassettes with Silicone Racks
Tray Inox con griglia in silicone - Recipientes de acero con equipo de silicona
Cassettes en acier avec aménagement en silicone

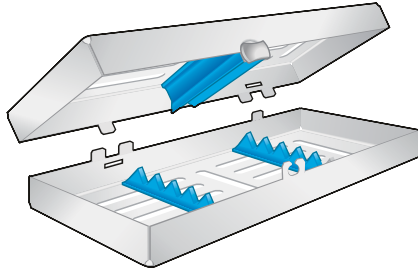

0218-FL Für 5 Instrumente
For 5 Instruments
Per 5 strumenti
Para 5 instrumentos
Pour 5 instruments
185 x 75 x 35 mm

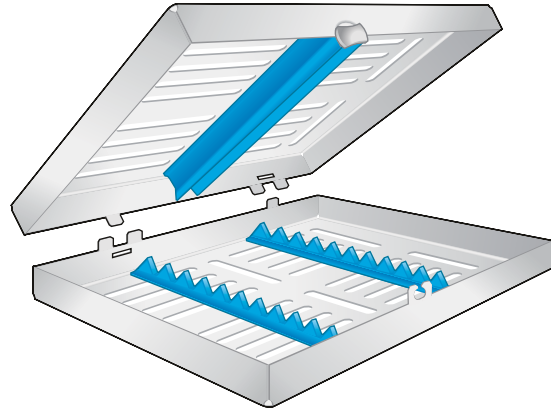

0218-GA Für 10 Instrumente
For 10 Instruments
Per 10 strumenti
Para 10 instrumentos
Pour 10 instruments
185 x 135 x 35 mm

0218-GB Für 20 Instrumente
For 20 Instruments
Per 20 strumenti
Para 20 instrumentos
Pour 20 instruments
290 x 185 x 35 mm

0319-FFF
0319-FGA
0319-FGF



Sterilcontainer,
mit Deckel- und Bodenperforation,
passend in gängige Praxisautoklaven
Containers for sterilization,
with perforation in lid and bottom,
suitable for common practice autoclaves
Contenitori dentali,
con coperchio e fondo perforato,
adatti a tutte le autoclavi comuni
Contenedores dentales,
con tapa perforada y fondo perforado,
aptos para autoclaves habituales
Containers stérile,
avec perforation du couvercle et du fond,
convenant aux autoclaves courants
pour cabinets médicaux

0319-GFB
0319-GFC
0319-GFD



Silikon Noppenmatten - Silicon Mats
Tappeti in aghi di silicone
Tapete en agujas de silicona
Tapis en Silicone

Sterilisierbar - Autoclavable
Autoclavabili - Esterilizable
Stérilisable

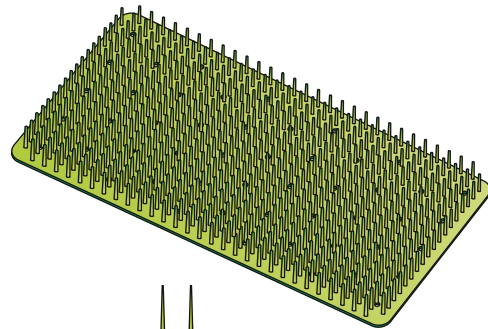

6 mm

1918-BAD
260 x 120 mm



0319-FFF
300 x 140 x 40 mm
0319-GFB
310 x 190 x 40 mm

0319-FGA
300 x 140 x 70 mm
0319-GFC
310 x 190 x 65 mm

0319-FGF
300 x 140 x 100 mm
0319-GFD
310 x 190 x 130 mm

Alu
Aluminium
Alluminio

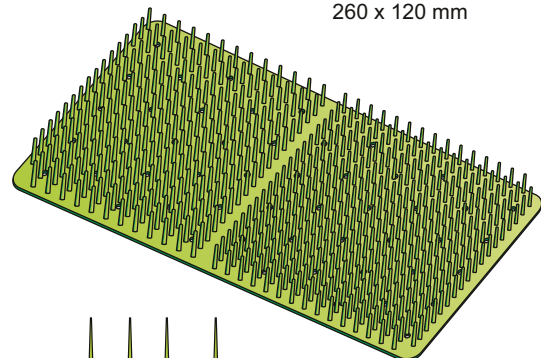

8 mm 10 mm

1918-BAE
270 x 180 mm

Alfabetisches Inhaltsverzeichnis
Alphabetical Index
Indice alfabetico
Indice alfabetico
Index alphabetique

Nummernverzeichnis
Alphanumerical Index
Indice alfanumerico
Indice alfanumerico
Index alphanumerique

Alphabetisches Inhaltsverzeichnis	Alphabetical Index	Indice alfabetico	Indice alfabetico	Index alphabétique
A				
ADSON , Absaugkanülen	55		- Ligaturscheren	6
- Pinzetten	8, 11		KEYES , Hautstanzen	45
- Titan-Pinzetten	10		KILIAN , Raspatorien	27
ADSON-BROWN , Pinzetten	8, 11		KLEINERT-KUTZ , Hohlmeißelzangen	52
B				
BABBUSH , Raspatorien	27		KOCHER , Arterienklemmen	16
BABY-CRILE-WOOD , Nadelhalter	15		KÖNIG , Raspatorien	27
BEASLEY-BABOCK , Pinzetten	11		KÜHNE , Pinzetten	9
BENNETT , Raspatorien	26		L	
BEYER , Hohlmeißelzangen	52		LA GRANGE , Wellenschliff Scheren	5
BISHOP , Wangenhalter	21		LEMPERT , Hohlmeißelzangen	51
BISHOP-HARMON , Pinzetten	7		LOCKLIN , Chirurgische Scheren	6
Skalpell	17		LUCAS , Scharfe Löffel	30
BROWN , Pinzetten	8		LUNIATSCHEK , Membranplatzierungsinstrumente	46
BRUENINGS , Zungenspatel	21		M	
C				
Absaugkanülen	54 - 55		MAGILL , Kathetereinführungszangen	22
CASTROVIEJO , Pinzetten	8		MALINIAC , Wundhaken	24
- Nadelhalter	13, 14		Hämmer	36
- Meißinstrumente	19		MATY , Mundsperrer	20
CAWOOD-MINNESOTA , Wangenhalter	21		McINTOSH , Laryngoskop	22
CITELLI , Hohlmeißelzangen	53		MEAD , Hämmer	36
CLEVELAND , Hohlmeißelzangen	52		MENEGHINI , Raspatorien	27
COLLIN , Zungenzangen	22		METZENBAUM , Chirurgische Scheren	4
Container	56		- Wellenschliff Scheren	5
CORN , Nahtpinzetten	7		MICRO-ADSON , Pinzetten	11
COTTLE , Sinus Lift Instrumente	32		MICRO-VASCULAR , Nadelhalter	15
COUPLAND , Absaugkanülen	54		MILLER-COLBURN , Sinus Lift Instrumente	32
COXETER , Scharfe Löffel	30		MINI-FRIEDMANN , Hohlmeißelzangen	51
CRILE-WOOD , Nadelhalter	15		MINNESOTA , Wangenhalter	21
Scharfe Löffel	30 - 33		MITCHEL , Dissektor	18
CUSHING , Wundhaken	24		MOLT , Raspatorien	26, 29
D				
DE BAKEY , Atraumatische Pinzetten	8		- Sinus Lift Instrumente	32
- Titan-Pinzetten	10		O	
DEAN , Chirurgische Scheren	6		OBWEGESER , Wundhaken	24
DESMARRES , Pinzetten	9		- Raspatorien	29
DINGMANN , Hohlmeißelzangen	53		OCHSENBEIN , Meißel	35
Wundhaken	23 - 25		Osteotome	37 - 44
E				
EPKER , Osteotome	34		P	
F				
FARABEUF , Wundhaken	20		PECK-JOSEPH , Chirurgische Scheren	4
Scheren	3 - 6		PELTON-CRANE , Absaugkanülen	55
FREER , Meißel	35		Arterienklemmen	16
- Raspatorien	28		Hohlmeißelzangen	51 - 53
FREER-YASARGIL , Raspatorien	28		Pinzetten	7 - 11
FRIEDMANN , Hohlmeißelzangen	51, 52		Nadelhalter	13 - 15
G				
GABON , Knochenmühle	48		PRICHARD , Raspatorien	26
GERALD , Pinzetten	9		R	
- Titan-Pinzetten	10		RADOLF , Hohlmeißelzangen	52
GIESSEN , Wundhaken	23		RAGNELL , Wundhaken	24
GILLIES , Pinzetten	7		RAGNELL-DAVIS , Wundhaken	24
GOLDMAN-FOX , Chirurgische Scheren	4		ROGER , Raspatorien	27
- Raspatorien	26		S	
Knochenschaber	47		SAUTHER , Wundhaken	23
H				
HALSTED-MOSQUITO , Arterienklemmen	16		Meißel	35
HENAHAN , Wundhaken	23		SCHEDE , Scharfe Löffel	33
HEPARIN , Spülkanüle	55		Raspatorien	26 - 29
HOUSE , Scharfe Löffel	30		SELDIN , Raspatorien	27
HOWARTH , Elevatorien	29		SINUS , Sinus Lift Instrumente	32
HURD , Elevatorien	29		Küretten	49
I				
IRIS , Wellenschliff Scheren	5		SMITH , Chirurgische Scheren	6
J				
JACOBSON , Scharfe Löffel	30		SPENCER , Ligaturscheren	6
- Nadelhalter	14		SPLIT , Scharfe Löffel	34
JACOBSON-MICRO , Arterienklemmen	16		STEVENS , Delicate Scissors	3
JAMESON-WERBER , Chirurgische Scheren	4		STITCH , Feine scheren	3
JOSEPH , Elevatorien	29		Meißinstrumente	19
K				
KELLY , Chirurgische Scheren	4		SWEDESH , Nadelhalter	15
L				
M				
N				
O				
P				
R				
S				
T				
V				
W				

Alphabetisches Inhaltsverzeichnis	Alphabetical Index	Indice alfabetico	Indice alfabetico	Index alphabétique
A				
ADSON , Suctions Tubes	55			
- Forceps	8, 11			
- Titanium Tissue Forceps	10			
ADSON-BROWN , Forceps	8, 11			
B				
BABBUSH , Periosteal	27			
BABY-CRILE-WOOD , Needle holders	15			
BEASLEY-BABOCK , Forceps	11			
BENNETT , Periosteal	26			
BEYER , Bone rongeurs	52			
BISHOP , Cheek Retractor	21			
BISHOP-HARMON , Forceps	7			
Scalpel	17			
BROWN , Forceps	8			
BRUENINGS , Tongue depressor	21			
C				
Suctions Tubes	54 - 55			
CASTROVIEJO , Forceps	8			
- Needle holders	13, 14			
- Measuring Instruments	19			
CAWOOD-MINNESOTA , Cheek Retractor	21			
CITELLI , Bone rongeur	53			
CLEVELAND , Bone rongeur	52			
COLLIN , Tongue holding forceps	22			
Containers	56			
CORN , Suture Pliers	7			
COTTLE , Sinus Lift Instruments	32			
COUPLAND , Suctions Tubes	54			
COXETER , Curettes	30			
CRILE-WOOD , Needle holders	15			
Curettes	30 - 33			
CUSHING , Retractors	24			
D				
DE BAKEY , Non-traumatic Forceps	8			
- Titanium Tissue Forceps	10			
DEAN , Surgical Scissors	6			
DESMARRES , Forceps	9			
DINGMANN , Bone rongeur	53			
Retractors	23 - 25			
E				
EPKER , Osteotomes	34			
F				
FARABEUF , Retractors	20			
Scissors	3 - 6			
FREER , Chisels	35			
- Periosteals	28			
FREER-YASARGIL , Periosteals	28			
FRIEDMANN , Bone rongeur	51, 52			
G				
GABON , Bone Mill	48			
GERALD , Forceps	9			
- Titanium Tissue Forceps	10			
GIESSEN , Retractors	23			
GILLIES , Forceps	7			
GOLDMAN-FOX , Surgical Scissors	4			
- Periosteals	26			
Bone scraper	47			
H				
HALSTED-MOSQUITO , Hemostatic Forceps	16			
HENAHAN , Retractors	23			
HEPARIN , Irrigation Needle	55			
HOUSE , Curettes	30			
HOWARTH , Elevator	29			
HURD , Elevator	29			
I				
IRIS , Wellenschliff Scissors	5			
J				
JACOBSON , Curettes	30			
- Needle holders	14			
JACOBSON-MICRO , Hemostatic Forceps	16			
JAMESON-WERBER , Surgical Scissors	4			
JOSEPH , Elevator	29			
K				
KELLY , Surgical Scissors	4			
			- Suture Scissors	6
			KEYES , Tissue Punches	45
			KILIAN , Periosteals	27
			KLEINERT-KUTZ , Bone rongeurs	52
			KOCHER , Hemostatic Forceps	16
			KÖNIG , Periosteals	27
			KÜHNE , Forceps	9
L				
			LA GRANGE , Wellenschliff Scissors	5
			LEMPERT , Bone rongeur	51
			LOCKLIN , Surgical Scissors	6
			LUCAS , Curettes	30
			LUNIATSCHEK , Membrane placement Instruments	46
M				
			MAGILL , Catheter introducing forceps	22
			MALINIAC , Retractors	24
			Hammer	36
			MATY , Mouth Gags	20
			McINTOSH , Laryngoscope	22
			MEAD , Hammer	36
			MENEGHINI , Periosteals	27
			METZENBAUM , Surgical Scissors	4
			- Wellenschliff Scissors	5
			MICRO-ADSON , Forceps	11
			MICRO-VASCULAR , Needle holders	15
			MILLER-COLBURN , Sinus Lift Instruments	32
			MINI-FRIEDMANN , Bone rongeurs	51
			MINNESOTA , Cheek Retractors	21
			MITCHEL , Dissector	18
			MOLT , Periosteal	26, 29
			- Sinus Lift Instruments	32
O				
			OBWEGESER , Retractors	24
			- Periosteals	29
			OCHSENBEIN , Chisels	35
			Osteotomes	37 - 44
P				
			PECK-JOSEPH , Surgical Scissors	4
			PELTON-CRANE , Suctions Tubes	55
			Hemostatic Forceps	16
			Bone rongeurs	51 - 53
			Forceps	7 - 11
			Needle holders	13 - 15
			PRICHARD , Periosteals	26
R				
			RADOLF , Bone rongeurs	52
			RAGNELL , Retractors	24
			RAGNELL-DAVIS , Retractors	24
			ROGER , Periosteals	27
S				
			SAUTHER , Retractors	23
			Chisels	35
			SCHEDE , Curettes	33
			Periosteals	26 - 29
			SELDIN , Periosteals	27
			SINUS , Sinus Lift Instruments	32
			Applications Guns	49
			SMITH , Surgical Scissors	6
			SPENCER , Suture Scissors	6
			SPLIT , Curettes	34
			STEVENS , Delicate Scissors	3
			STITCH , Delicate Scissors	3
			Measuring Instruments	19
			SWEDESH , Needle holders	15
T				
			TESSIER , Chicels	35
V				
			VOLKMANN , Bone scoops	33
			- Curettes	30
W				
			WALTON , Delicate Scissors	3
			WIEDER , Tongue Depressor	22
			WEITLANER , Tibial and iliac Retractor	25
			WILLIGER , Elevator	29
			WOLFF , Bone rongeurs	53
			WOODSON , Elevator	26

Alphabetisches Inhaltsverzeichnis	Alphabetical Index	Indice alfabetico	Indice alfabetico	Index alphabétique
A				
ADSON , Cannule per aspirazione	55			
- Pinzette	8, 11			
- Pinzette in titanio	10			
ADSON-BROWN , Pinzette	8, 11			
B				
BABBUSH , Scollaperiosteo	27			
BABY-CRILE-WOOD , Port'aghi	15			
BEASLEY-BABOCK , Pinzette	11			
BENNETT , Scollaperiosteo	26			
BEYER , Pinze ossivore	52			
BISHOP , Separatore per guancia	21			
BISHOP-HARMON , Pinzette	7			
Bisturi	17			
BROWN , Pinzette	8			
BRUENINGS , Abbassalingua	21			
C				
Cannule per aspirazione	54 - 55			
CASTROVIEJO , Pinzette	8			
- Port'aghi	13, 14			
- Strumenti per misura	19			
CAWOOD-MINNESOTA , Separatore per guancia	21			
CITELLI , Pinze ossivore	53			
CLEVELAND , Pinze ossivore	52			
COLLIN , Pinze tira-lingua	22			
Contenitori per sterilizzazione	56			
CORN , Pinzette per sutura	7			
COTTLE , Strumento per rialzo del seno	32			
COUPLAND , Cannule per aspirazione	54			
COXETER , Curette	30			
CRILE-WOOD , Port'aghi	15			
Curette	30 - 33			
CUSHING , Divaricatori	24			
D				
DE BAKEY , Pinzette atraumatiche	8			
- Pinzette in titanio	10			
DEAN , Forbici chirurgiche	6			
DESMARRES , Pinzette	9			
DINGMANN , Pinze ossivore	53			
Divaricatori	23 - 25			
E				
EPKER , Osteotomi	34			
F				
FARABEUF , Divaricatori	20			
Forbici	3 - 6			
FREER , Scalpelli	35			
- Scollaperiosteo	28			
FREER-YASARGIL , Scollaperiosteo	28			
FRIEDMANN , Pinze ossivore	51, 52			
G				
GABON , Macinino per osso	48			
GERALD , Pinzette	9			
- Pinzette in titanio	10			
GIESSEN , Divaricatori	23			
GILLIES , Pinzette	7			
GOLDMAN-FOX , Forbici chirurgiche	4			
- Scollaperiosteo	26			
Grattini per osso	47			
H				
HALSTED-MOSQUITO , Pinze emostatiche	16			
HENAHAN , Divaricatori	23			
HEPARIN , Aghi da lavaggio	55			
HOUSE , Curette	30			
HOWARTH , Elevatore	29			
HURD , Elevatore	29			
I				
IRIS , Forbici Wellenschliff	5			
J				
JACOBSON , Curette	30			
- Port'aghi	14			
JACOBSON-MICRO , Pinze emostatiche	16			
JAMESON-WERBER , Forbici chirurgiche	4			
JOSEPH , Elevatore	29			
K				
KELLY , Forbici chirurgiche	4			
		- Forbici per suture		6
		KEYES , Punche da Biopsia		45
		KILIAN , Scollaperiosteo		27
		KLEINERT-KUTZ , Pinze ossivore		52
		KOCHER , Pinze emostatiche		16
		KÖNIG , Scollaperiosteo		27
		KÜHNE , Pinzette		9
L				
		LA GRANGE , Forbici Wellenschliff		5
		LEMPERT , Pinze ossivore		51
		LOCKLIN , Forbici chirurgiche		6
		LUCAS , Curette		30
		LUNIATSCHEK , Strumento per posizionare membrana		46
M				
		MAGILL , Pinze da intubazione		22
		MALINIAC , Divaricatori		24
		Martelli		36
		MATY , Apribocca		20
		McINTOSH , Diagnostica		22
		MEAD , Martello		36
		MENEGHINI , Scollaperiosteo		27
		METZENBAUM , Forbici chirurgiche		4
		- Forbici Wellenschliff		5
		MICRO-ADSON , Pinzette		11
		MICRO-VASCULAR , Port'aghi		15
		MILLER-COLBURN , Strumento per rialzo del seno		32
		MINI-FRIEDMANN , Pinze ossivore		51
		MINNESOTA , Separatore per guancia		21
		MITCHELL , Dissettore		18
		MOLT , Scollaperiosteo		26, 29
		- Strumento per rialzo del seno		32
O				
		OBWEGESER , Divaricatori		24
		- Scollaperiosteo		29
		OCHSENBEIN , Scalpelli		35
		Osteotomi		37 - 44
P				
		PECK-JOSEPH , Forbici chirurgiche		4
		PELTON-CRANE , Cannule per aspirazione		55
		Pinze emostatiche		16
		Pinze ossivore		51 - 53
		Pinzette		7 - 11
		Port'aghi		13 - 15
		PRICHARD , Scollaperiosteo		26
R				
		RADOLF , Pinze ossivore		52
		RAGNELL , Divaricatori		24
		RAGNELL-DAVIS , Divaricatori		24
		ROGER , Scollaperiosteo		27
S				
		SAUTHER , Divaricatori		23
		Scalpelli		35
		SCHEDE , Cucchiali per osso		33
		Scollaperiosteo		26 - 29
		SELDIN , Scollaperiosteo		27
		SINUS , Strumento per rialzo del seno		32
		Siringhe per osso		49
		SMITH , Forbici chirurgiche		6
		SPENCER , Forbici per suture		6
		SPLIT , Cucchiali per osso		34
		STEVENS , Forbici delicate		3
		STITCH , Forbici delicate		3
		Strumenti per misura		19
		SWEDESH , Port'aghi		15
T				
		TESSIER , Scalpelli		35
V				
		VOLKMANN , Cucchiali per osso		33
		- Curette		30
W				
		WALTON , Forbici delicate		3
		WIEDER , Abbassalingua		22
		WEITLANER , Divaricatori per tibia e cresta iliaca		25
		WILLIGER , Elevatore		29
		WOLFF , Pinze ossivore		53
		WOODSON , Elevatore		26



ideal-tek
manufacturer & supplier of precision instruments 

Ideal-tek SA
via Motta 4
6828 Balerna
Switzerland

Phone: +41 91 683 32 29
Fax: +41 91 683 03 71
E-mail: info@ideal-tek.com