



Arthroskopie-Katalog

Arthroscopy Catalog
Catalogo di Artrosopia
Catàlogo Artrosopia
Catalogue Arthroscopie

Arthroskopie
Instrumente

Arthroscopy
Instruments

Strumenti per
Artroscopia

Instrumentos
para Artroscopia

Instruments
pour Arthroscopie

Scalpel-Knife
Skalpelmesser



0118-GB
130 mm

Banana knife
toothed
Bananamesser
glatt



0118-GC
130 mm

Meniscotome Smillie
4 mm straight edge
Meniskotome
Smillie 4 mm
Gerade Schneide

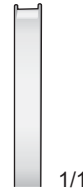

0118-GD
130 mm

Meniscotome Smillie
5 mm straight edge
Meniskotome
Smillie 5 mm
Gerade Schneide



0118-GE
130 mm

Knife
Incizionmesser

3 mm

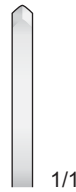

0118-GF
130 mm

Knife
Incizionmesser

5 mm



0118-GG
130 mm

Hook knife 90°
Hakenmesser 90°

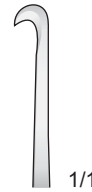

0118-GH
130 mm

Knife
Messer



0118-GI
130 mm

Meniscotome Smillie
5 mm round edge
Meniskotome
Smillie 5 mm
Runde Schneide



0118-GL
130 mm

Hook probe
pointed
Hakensonde
Spitz



0118-HA
130 mm

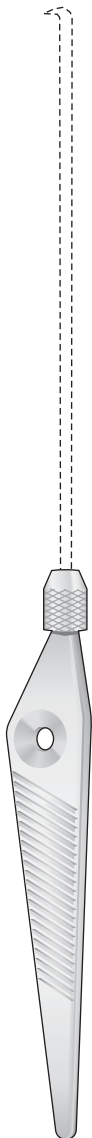

0118-GA
125 mm

Arthroskopie
Instrumente

Arthroscopy
Instruments

Strumenti per
Artrosopia

Instrumentos
para Artrosopia

Instruments
pour Arthroscopie

Handle only
Griff allein
125 mm

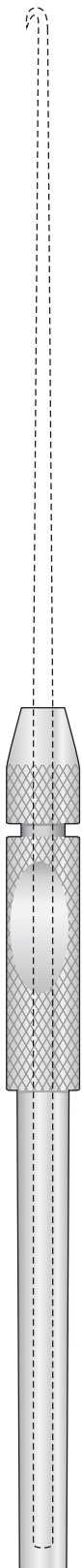

Hook probe pointed
Hakensonde spitz



0118-BB
220 mm

Knife 45°
Messer 45°



0118-BC
220 mm

Bajonet knife 45°
Bajonettmesser 45°



0118-BD
225 mm

Banana knife
toothed
Bananamesser
gezahnt

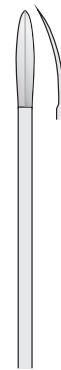

0118-BE
225 mm

Banana knife
smooth
Bananamesser
glatt

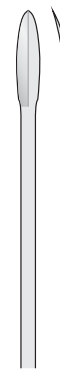

0118-BF
225 mm

Spoon Ø 3 mm
30° curved
Löffel Ø 3 mm
30° gebogen

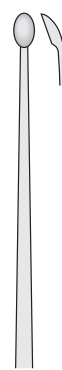

0118-BG
225 mm

Ring-Kürette Ø
3 mm
Ring-Curette Ø
3 mm



0118-BH
220 mm

Ring-Kürette Ø
7 mm
Ring-Curette Ø
7 mm



0118-BI
225 mm

Probe graduated
2,5 mm
Sonde graduirert
2,5 mm



0118-BL
220 mm

Probe graduated
3,5 mm
Sonde graduirert
3,5 mm



0118-CA
220 mm

Meniskotome
Smillie 3 mm
gerade Schneide
Meniscotome Smillie
3 mm straight edge



0118-CB
225 mm

Meniskotome
Smillie 5 mm
gerade Schneide
Meniscotome Smillie
5 mm straight edge



0118-CC
225 mm

Meniskotome Smillie
7 mm round edge
Meniskotome Smillie
7 mm runde Schneide



0118-CD
220 mm

Scalpel-Knife
Skalpelmesser



0118-CE
225 mm

Knife, toothed,
straight
Messer gezahnt,
gerade



0118-CF
225 mm

Knife, toothed,
curved 30°, left
Messer gezahnt,
gebogen, 30°, links



0118-CG
220 mm

Knife, toothed,
curved 30°, right
Messer gezahnt,
gebogen, 30°, rechts



0118-CH
220 mm

Sickle Knife
Sichelmesser



0118-CI
220 mm

Hook Knife 90°
Hakenmesser 90°



0118-CL
220 mm

0118-BA
125 mm

Arthroskopie
Instrumente

Arthroscopy
Instruments

Strumenti per
Artroscopia

Instrumentos
para Artroscopia

Instruments
pour Arthroscopie

Hook-Knife 90°
Hakenmesser 90°



0118-DA
225 mm

Meniscotome
Meniskotome



0118-DB
220 mm

Knife 45°
Messer 45°



0118-DC
220 mm

Banana-Knife
Bananamesser

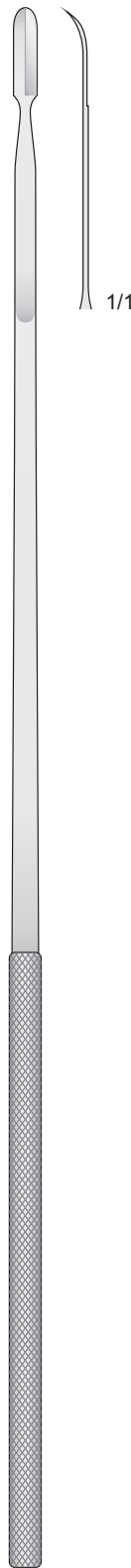

0118-DD
220 mm

Scalpel-Knife
Skalpelmesser



0118-DE
220 mm

Hook-Probe 4 mm
Hakensonde 4 mm



0118-DF
220 mm

**Arthroskopie
Instrumente**

**Arthroscopy
Instruments**

**Strumenti per
Artroscopia**

**Instrumentos
para Artroscopia**

**Instruments
pour Arthroscopie**

Spoon ø 3 mm
30° curved
Löffel ø 3 mm
30° gebogen



0118-DG
220 mm

Smille Meniscotome
3 mm width
Smille Meniskotome
3 mm breit



0118-DH
220 mm

Rosetten-Knife
stright
Rosettenmesser
gerade



0118-DI
220 mm

Banana-Knife
serrated
Bananamesser
gezahnt

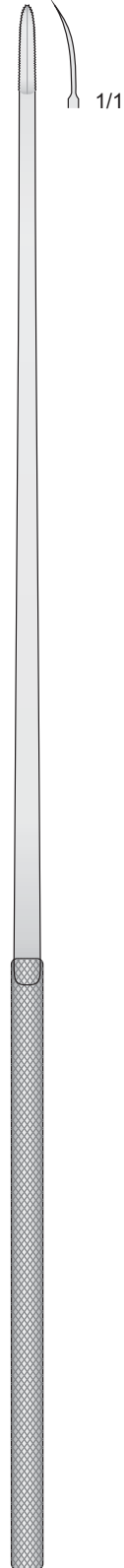









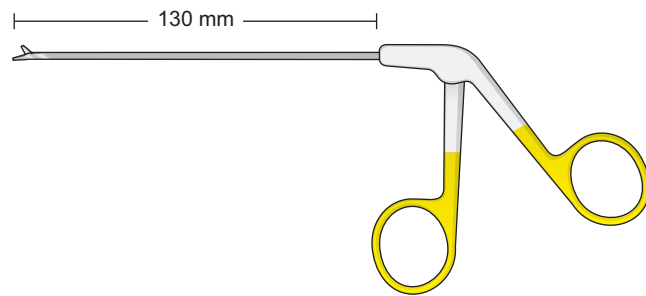

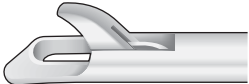
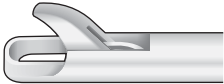
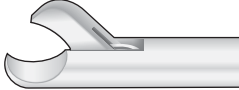
0118-DL
230 mm

Ring-Curette ø 3 mm
30° curved
Ring-Kürette ø 3 mm
30° gebogen



0118-EA
220 mm



	Ø mm	Hakenstanzen mit Schaufel Hook Punches with Scoop Pinze per biopsia con pala Pinzas para biopsia con pala Pinces à biopsie à pelle	Hakenstanzen abgesetzt Hook Punches set down Pinze per biopsia Pinzas para biopsia Pinces à biopsie	Hakenschere - Hook Scissors Pinze a gancio - Tijeras de gancho Pinces - ciseaux
		 L = 5,0 mm B = 1,6 mm	 L = 5,0 mm B = 1,6 mm	
Gerade - Straight Diritta - Recto - Droit 	2,7	0614-DHA	0614-DIA	0614-DLA
	3,5	0614-DBA	0614-DCA	0614-DEA
30° rechts - right destra - derecha - droite 	2,7	0614-DHB	0614-DIB	0614-DLB
	3,5	0614-DBB	0614-DCB	0614-DEB
30° links - left - sinistra izquierda - gauche 	2,7	0614-DHC	0614-DIC	0614-DLC
	3,5	0614-DBC	0614-DCC	0614-DEC
45° rechts - right destra - derecha - droite 	2,7	0614-DHD	0614-DID	0614-DLD
	3,5	0614-DBD	0614-DCD	0614-DED
45° links - left - sinistra izquierda - gauche 	2,7	0614-DHE	0614-DIE	0614-DLE
	3,5	0614-DBE	0614-DCE	0614-DEE
7° auf - up - sopra 	2,7	0614-DHF	0614-DIF	0614-DLF
	3,5	0614-DBF	0614-DCF	0614-DEF
7° ab - down - sotto 	2,7	0614-DHG	0614-DIG	0614-DLG
	3,5	0614-DBG	0614-DCG	0614-DEG
15° auf - up - sopra 	2,7	0614-DHH	0614-DIH	0614-DLH
	3,5	0614-DBH	0614-DCH	0614-DEH
15° ab - down - sotto 	2,7	0614-DHI	0614-DII	0614-DLI
	3,5	0614-DBI	0614-DCI	0614-DEI

Arthroskopie



Arthroscopy

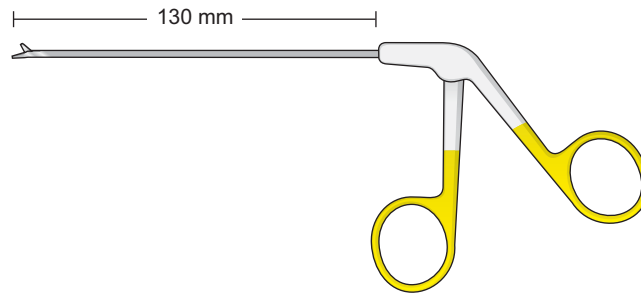

Artroscopia

Artroscopia

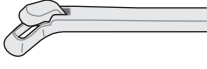







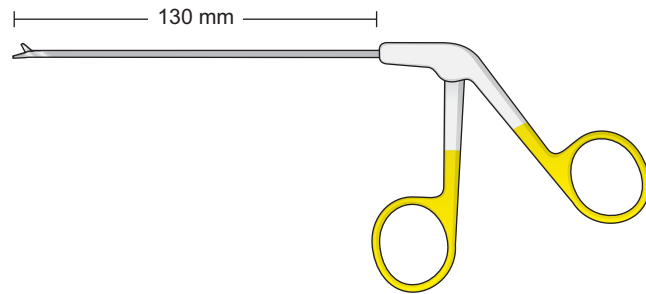

Arthroscopie

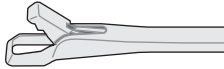

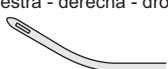
		45°		90°	
	Ø mm	Stanze mit Schaufel Punch with Scoop Pinza con pala Pinzas con pala Pince à pelle  L = 4,5 mm B = 1,6 mm	Stanze stumpf Punch blunt Pinza smussa Pinzas romas Pince mousse  L = 4,5 mm B = 1,6 mm	Stanze mit Schaufel Punch with Scoop Pinza con pala Pinzas con pala Pince à pelle  L = 4,5 mm B = 1,6 mm	Stanze stumpf Punch blunt Pinza smussa Pinzas romas Pince mousse  L = 4,5 mm B = 1,6 mm
recths abgewinkelt right angled angolata destra angolada a la derecha courbe à droits	3,5	0614-DDA	0614-DDE	0614-DDC	0614-DDG
links abgewinkelt left angled angolata sinistra angolada a la izquierda courbe à gauche	3,5	0614-DOB	0614-DOF	0614-DOD	0614-DOH

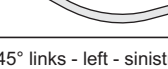
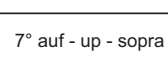
		90°	
	Ø mm	Breitmaulstanze klein Wide Jaw Punch small  L = 7,0 mm B = 1,8 mm	Breitmaulstanze mittel Wide Jaw Punch medium  L = 7,0 mm B = 3,0 mm
recths abgewinkelt right angled angolata destra angolada a la derecha courbe à droits	3,5	0614-DHL	0614-DBL
links abgewinkelt left angled angolata sinistra angolada a la izquierda courbe à gauche	3,5	0614-DIL	0614-DCL

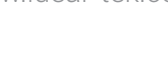

	Ø mm	Breitmaulstanze klein Wide Jaw Punch small  L = 6,0 mm B = 2,5 mm	Breitmaulstanze mittel Wide Jaw Punch medium  L = 5,0 mm B = 3,5 mm	Breitmaulstanze groß Wide Jaw Punch large  L = 5,0 mm B = 4,5 mm
Gerade - Straight Diritta - Recto - Droit 	3,5	0614-EAB	0614-EBA	0614-EBL
30° rechts - right destra - derecha - droite 	3,5	0614-EAC	0614-EBB	0614-ECA
30° links - left - sinistra izquierda - gauche 	3,5	0614-EAD	0614-EBC	0614-ECB
45° rechts - right destra - derecha - droite 	3,5	0614-EAE	0614-EBD	0614-ECC
45° links - left - sinistra izquierda - gauche 	3,5	0614-EAF	0614-EBE	0614-ECD
7° auf - up - sopra 	3,5	0614-EAG	0614-EBF	0614-ECE
7° ab - down - sotto 	3,5	0614-EAH	0614-EBG	0614-ECF
15° auf - up - sopra 	3,5	0614-EAI	0614-EBH	0614-ECG
15° ab - down - sotto 	3,5	0614-EAL	0614-EBI	0614-ECH

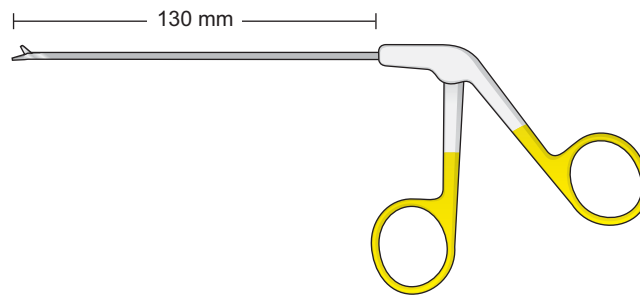

15° aufwärts gefräst - 15° up milled

		Breitmaulstanze klein Wide Jaw Punch small	Breitmaulstanze mittel Wide Jaw Punch medium	Breitmaulstanze groß Wide Jaw Punch large
	Ø mm	 L = 6,0 mm B = 2,5 mm	 L = 5,0 mm B = 3,5 mm	 L = 5,0 mm B = 4,5 mm
Gerade - Straight Diritta - Recto - Droit 	3,5	0614-ECI	0614-EDH	0614-EEG
30° rechts - right destra - derecha - droite 	3,5	0614-ECL	0614-EDI	0614-EEH
30° links - left - sinistra izquierda - gauche 	3,5	0614-EDA	0614-EDL	0614-EEI
45° rechts - right destra - derecha - droite 	3,5	0614-EDB	0614-EEA	0614-EEL
45° links - left - sinistra izquierda - gauche 	3,5	0614-EDC	0614-EEB	0614-EFA
7° auf - up - sopra 	3,5	0614-EDD	0614-EEC	0614-EFB
7° ab - down - sotto 	3,5	0614-EDE	0614-EED	0614-EFC
15° auf - up - sopra 	3,5	0614-EDF	0614-EEE	0614-EFD
15° ab - down - sotto 	3,5	0614-EDG	0614-EEF	0614-EFE

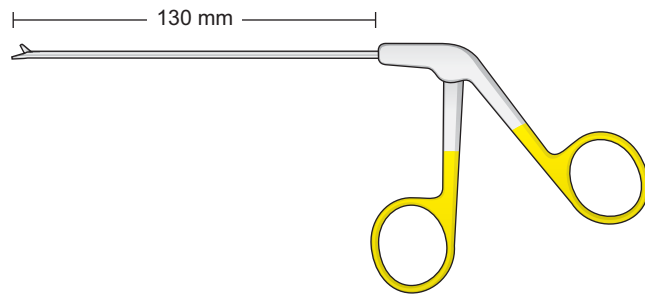

1x2 Zähne - 1x2 Theets - 1x2 Denti
1x2 Dientes - 1x2 Dents

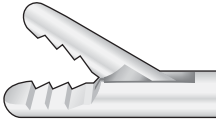
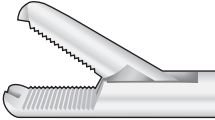
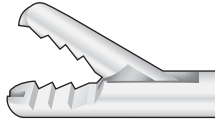
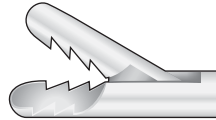
	Ø mm	Faßzange Grasping Forceps Pinza da presa Pinza para agarrar Pinces à préhension	Faßzange Grasping Forceps Pinza da presa Pinza para agarrar Pinces à préhension	Faßzange Grasping Forceps Pinza da presa Pinza para agarrar Pinces à préhension	Faß- und Biopsiezange Grasping - Biopsy Forceps Pinza da presa e biopsia Pinza para agarrar y biopsia Pinces préhension - biopsie
ohne Sperre without catch senza cremagliera sin cremallera sans crémaillère	2,7				
ohne Sperre without catch senza cremagliera sin cremallera sans crémaillère	3,5	0614-DFA	0614-DFD	0614-DFF	0614-DFI
ohne Sperre without catch senza cremagliera sin cremallera sans crémaillère	3,5	0614-DFB	0614-DFE	0614-DFG	0614-DFL
mit Sperre with catch con cremagliera con cremallera avec crémaillère	3,5	0614-DFC	0614-DFE	0614-DFH	0614-DGA

Meniskus Faßzangen - Meniscus Grasping forceps
Pinza per menisco - Pinzas para menisco
Pinces à ménisque

110 mm

1x2 Zähne
1x2 Theets
1x2 Denti
1x2 Dientes
1x2 Dents

Gerade - Straight Dritta - Recta Droit	0614-DGF
Rechts Gebogen - Right curved Curva a destra - Curva a la derecha Courbe a droites	0614-DGG
Links Gebogen - Left curved Curva a sinistra - Curva a la izquierda Courbe a gauche	0614-DGH

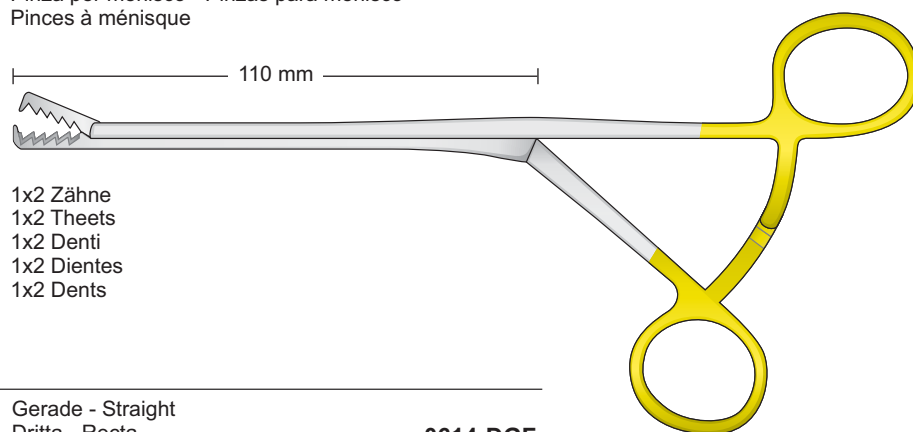

Arthroskopie
Mikro-zangen

Arthroscopy
Micro forceps

Micro Pinze
per Artroscozia

Micro pinzas
para Artroscozia

Micro Pinces
pour Arthroscopie

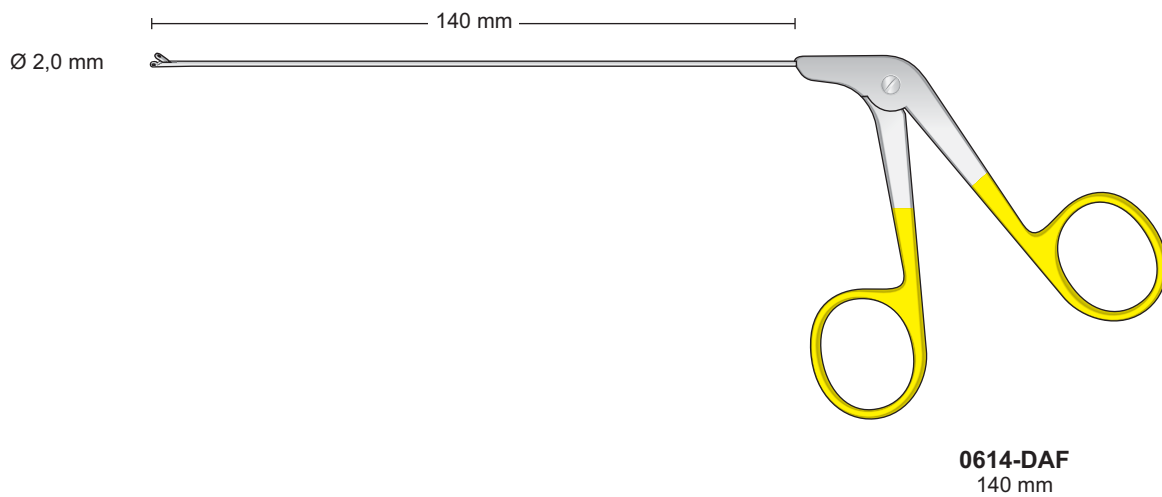
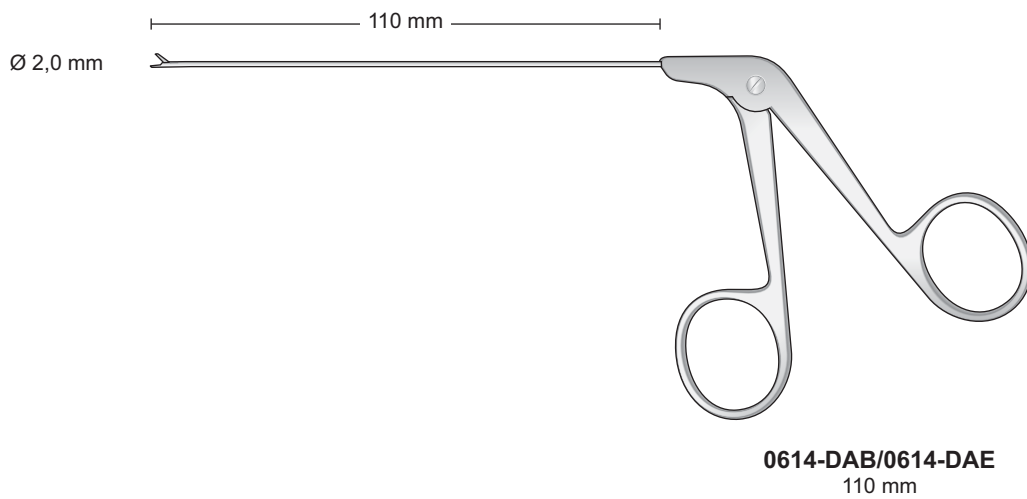

Indice alfanumerico		Alfanumerical Index		Nummernverzeichnis		Index alphabétique		Indice alfanumerico	
Article	Page	Article	Page	Article	Page	Article	Page	Article	Page
0118-BA	4	0614-DDC	8	0614-EBD	9				
0118-BB	4	0614-DDD	8	0614-EBE	9				
0118-BC	4	0614-DDE	8	0614-EBF	9				
0118-BD	4	0614-DDF	8	0614-EBG	9				
0118-BE	4	0614-DDG	8	0614-EBH	9				
0118-BF	4	0614-DDH	8	0614-EBI	9				
0118-BG	4	0614-DEA	7	0614-EBL	9				
0118-BH	4	0614-DEB	7	0614-ECA	9				
0118-BI	4	0614-DEC	7	0614-ECB	9				
0118-BL	4	0614-DED	7	0614-ECC	9				
0118-CA	4	0614-DEE	7	0614-ECD	9				
0118-CB	4	0614-DEF	7	0614-ECE	9				
0118-CC	4	0614-DEG	7	0614-ECF	9				
0118-CD	4	0614-DEH	7	0614-ECG	9				
0118-CE	4	0614-DEI	7	0614-ECH	9				
0118-CF	4	0614-DEJ	11	0614-ECI	10				
0118-CG	4	0614-DFB	11	0614-ECL	10				
0118-CH	4	0614-DFC	11	0614-EDA	10				
0118-CI	4	0614-DFD	11	0614-EDB	10				
0118-CL	4	0614-DFE	11	0614-EDC	10				
0118-DA	5	0614-DFG	11	0614-EDD	10				
0118-DB	5	0614-DFH	11	0614-EDE	10				
0118-DC	5	0614-DFI	11	0614-EDF	10				
0118-DD	5	0614-DFJ	11	0614-EDG	10				
0118-DE	5	0614-DFK	11	0614-EDH	10				
0118-DF	5	0614-DGA	11	0614-EDI	10				
0118-DG	6	0614-DGF	11	0614-EDL	10				
0118-DH	6	0614-DGG	11	0614-EEA	10				
0118-DI	6	0614-DGH	11	0614-EEB	10				
0118-DL	6	0614-DHA	7	0614-EEC	10				
0118-EA	6	0614-DHB	7	0614-EED	10				
0118-GA	3	0614-DHC	7	0614-EEE	10				
0118-GB	3	0614-DHD	7	0614-EEF	10				
0118-GC	3	0614-DHE	7	0614-EEG	10				
0118-GD	3	0614-DHF	7	0614-EEH	10				
0118-GE	3	0614-DHG	7	0614-EEI	10				
0118-GF	3	0614-DHH	7	0614-EEL	10				
0118-GG	3	0614-DHI	7	0614-EFA	10				
0118-GH	3	0614-DHL	8	0614-EFB	10				
0118-GI	3	0614-DIA	7	0614-EFC	10				
0118-GL	3	0614-DIB	7	0614-EFD	10				
0118-HA	3	0614-DIC	7	0614-EFE	10				
		0614-DID	7						
0614-DAB	12	0614-DIE	7						
0614-DAC	12	0614-DIF	7						
0614-DAD	12	0614-DIG	7						
0614-DAE	12	0614-DIH	7						
0614-DAF	12	0614-DII	7						
0614-DBA	7	0614-DIL	8						
0614-DBB	7	0614-DLA	7						
0614-DBC	7	0614-DLB	7						
0614-DBD	7	0614-DLC	7						
0614-DBE	7	0614-DLD	7						
0614-DBF	7	0614-DLE	7						
0614-DBG	7	0614-DLF	7						
0614-DBH	7	0614-DLG	7						
0614-DBI	7	0614-DLH	7						
0614-DBL	8	0614-DLI	7						
0614-DCA	7	0614-EAB	9						
0614-DCB	7	0614-EAC	9						
0614-DCC	7	0614-EAD	9						
0614-DCD	7	0614-EAE	9						
0614-DCE	7	0614-EAF	9						
0614-DCF	7	0614-EAG	9						
0614-DCG	7	0614-EAH	9						
0614-DCH	7	0614-EAI	9						
0614-DCI	7	0614-EAL	9						
0614-DCL	8	0614-EBA	9						
0614-DDA	8	0614-EBB	9						
0614-DCB	8	0614-EBC	9						



Ideal-tek SA
via Motta 4
6828 Balerna
Switzerland

Phone: +41 91 683 32 29
Fax: +41 91 683 03 71
E-mail: info@ideal-tek.com